

Fit tips!

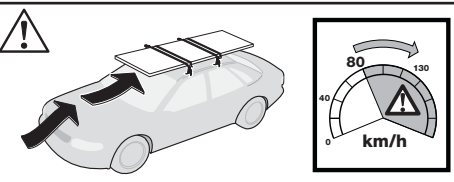

838

GB Accessories	SK Príslušenstvo
D Zubehör	SLO Dodatki
F Accessoires	HR Dodaci
NL Accessoires	HU Tartozékok
I Accessori	GR Παρελκόμενα
E Accesorios	TR Aksesuarlar
PT Acessórios	中文 附件
S Tillbehör	日本語 付属品
FIN Lisävarusteet	한국어 액세서리
EST Lisavarustus	ไทย อุปกรณ์เสริม
LAT Piederumi	
LIT Priedai	
PL Akcesoria	
RU Аксессуары	
CZ Doplnky	

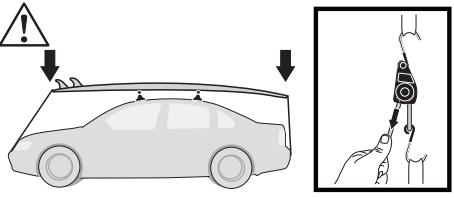
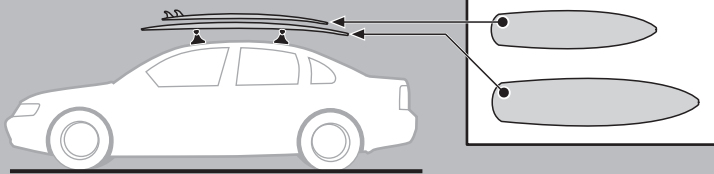
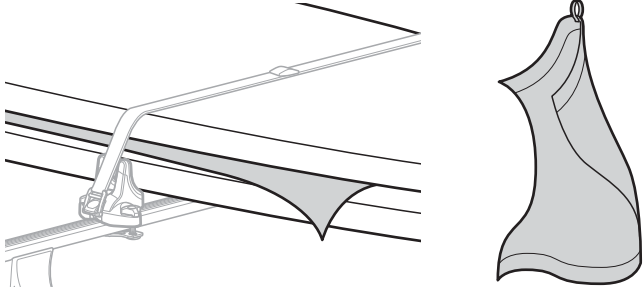
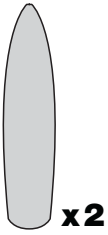

THULE[®]
SWEDEN

GB Fitting instructions	SK Návod na montáž
D Montageanleitung	SLO Navodila za pritrjevanje
F Instructions de montage	HR Uputa za sastavljanje
NL Montage-instructies	HU A felszerelés módja
I Istruzioni per il montaggio	GR Οδηγίες συναρμολόγησης
E Instrucciones de montaje	TR Montaj talimatları
PT Instruções de Montagem	中文 安装说明
S Monteringsanvisning	日本語 取扱(取付)説明書
FIN Asennusohje	한국어 장착 지침
EST Paigaldusjuhend	ไทย คำแนะนำการติดตั้ง
LAT Stiprināšanas instrukcija	
LIT Pritvirtinimo instrukcijos	
PL Instrukcja montażu	
RU Инструкции по установке	
CZ Návod na montáž	

832
832000



Follow me...

THULE[®]
SWEDEN

Box 69, 330 33 Hillerstorp, SWEDEN
www.thule.com

20100520•4DF/501-7008-05

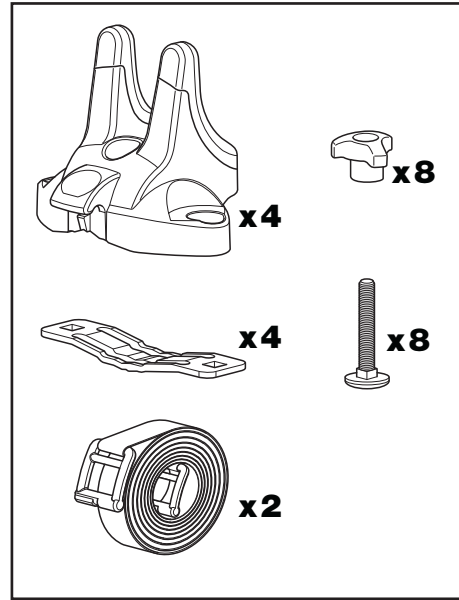
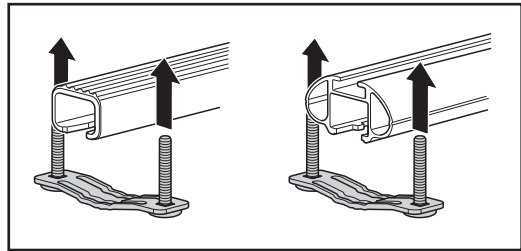
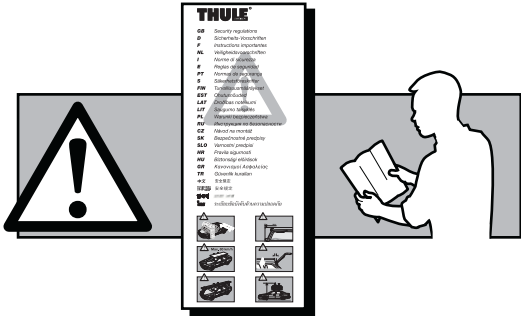

1

- * GB Only a few turns
- * D Nur wenige Umdrehungen
- * F Quelques tours uniquement
- * NL Slechts enkele slagen
- * I Solo qualche giro
- * E Sólo algunas vueltas
- * PT Noções básicas
- * S Endast några varv
- * FIN Vain muutama kierros
- * EST Ainult mõni pööre
- * LAT Tikai daži apgrīzieni
- * LIT Tik keli pasukimai
- * PL Wystarczy kilka obrotów
- * RU Достаточно нескольких оборотов
- * CZ Pouze několik otáček
- * SK Len niekoľko otáčok
- * SLO Le nekaj obratov
- * HR Samo nekoliko okreta
- * HU Csak néhány fordítás
- * GR Μόνο μερικές στροφές
- * TR Yalnız birkaç kez çevirme
- * 中文 只有几个转向
- * 한국어 두 세번만
- * 日本語 数回転のみ
- * ไทย หมุนเพียงไม่กี่รอบ

2

Min 610 mm

3 Nm

3