

Thule Rapid System 775

> Instructions

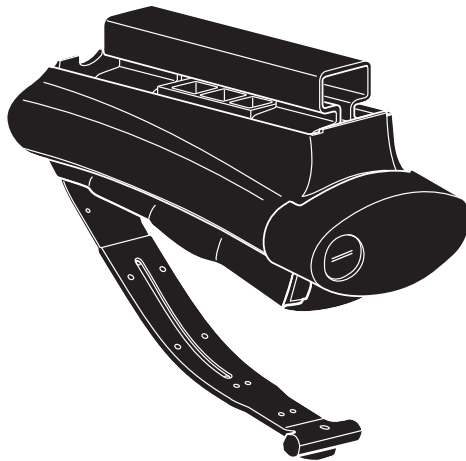

ISO 11154-E

CITY CRASH

Complies with ISO norm

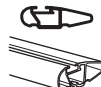

THULE WingBar



THULE SlideBar



THULE ProBar

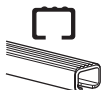

THULE SquareBar

775000

C.20150501
501-6882-06

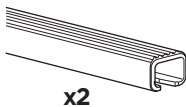
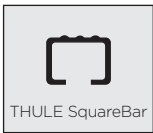
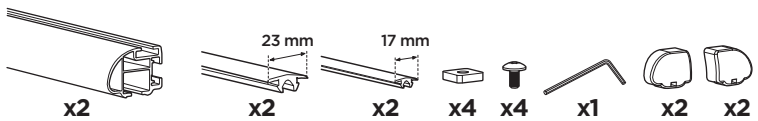
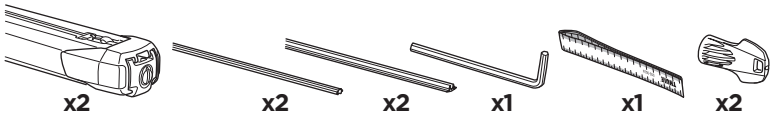
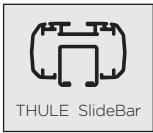
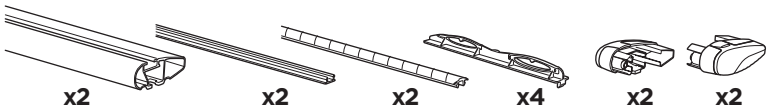
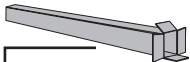
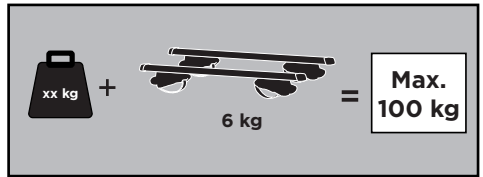
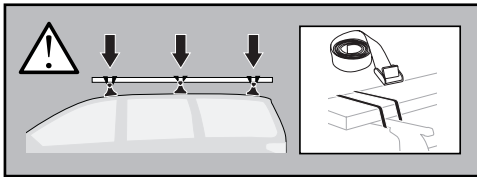
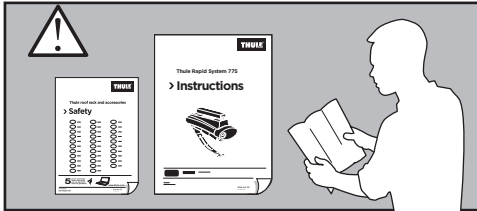
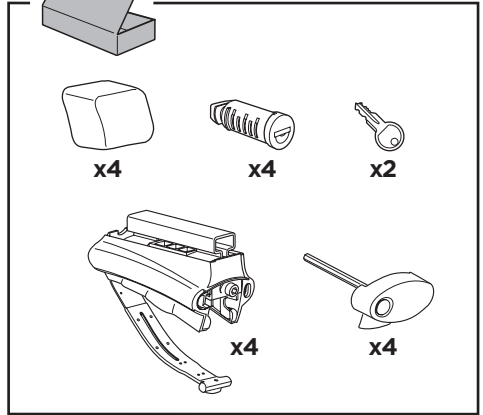
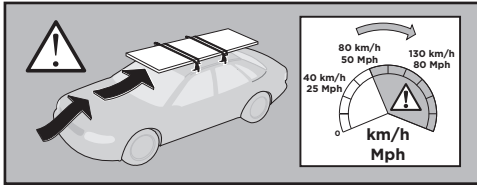

1

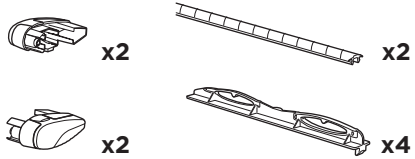

A

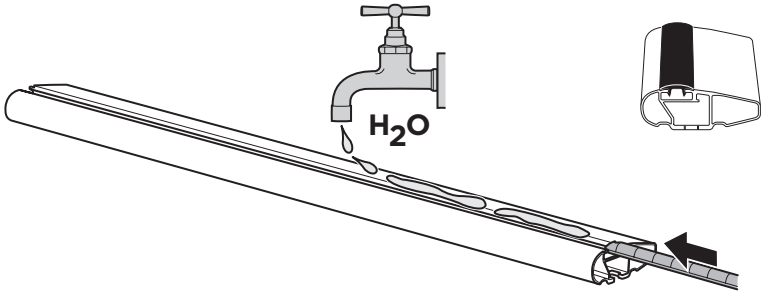

B

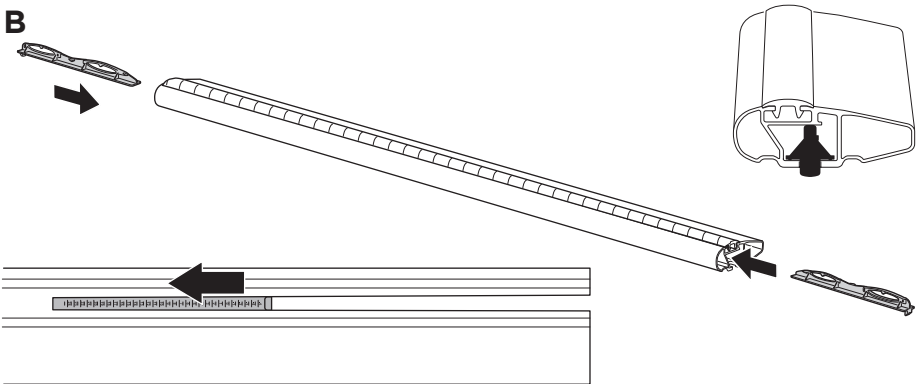

C

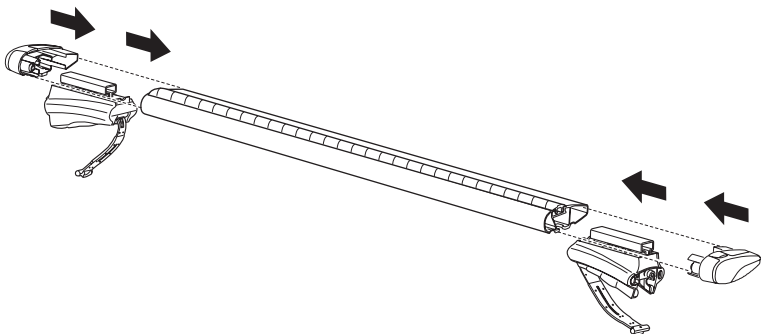

1

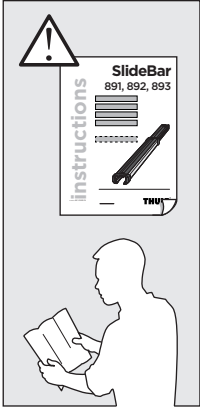
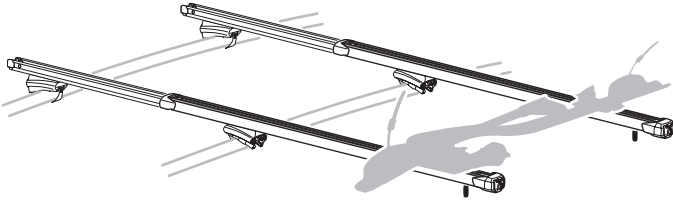
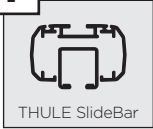

1

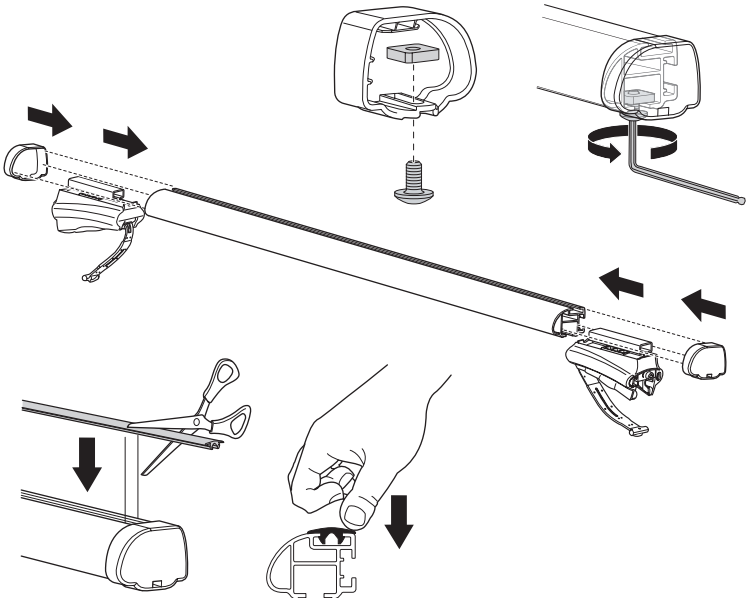
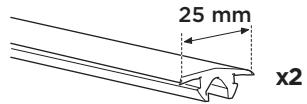

1

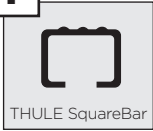

x4

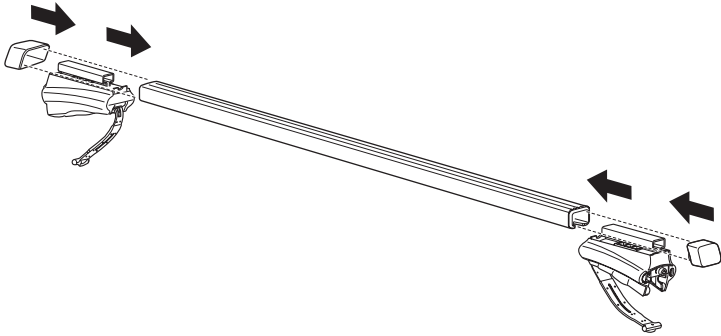

2



x4



x2

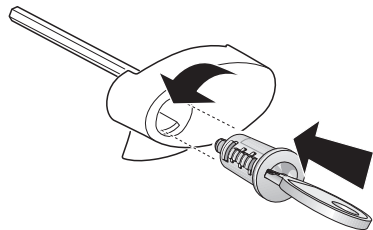
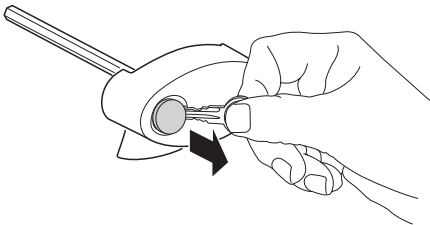

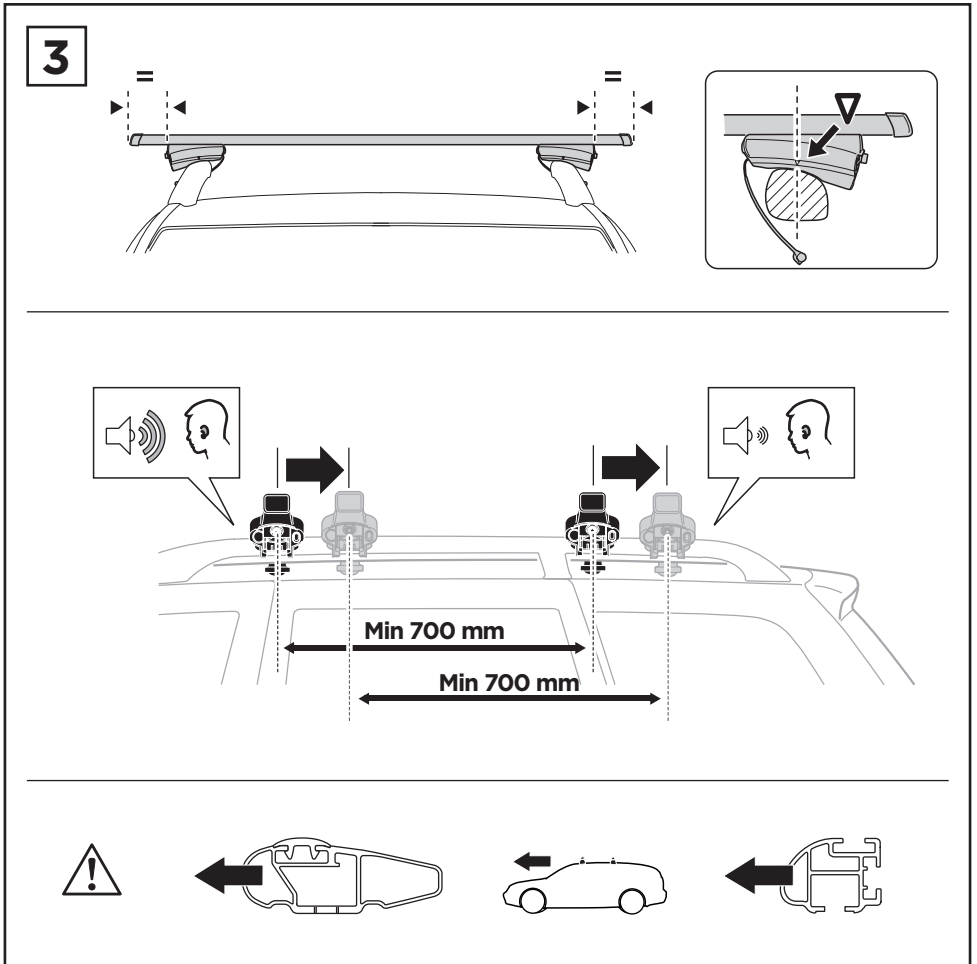
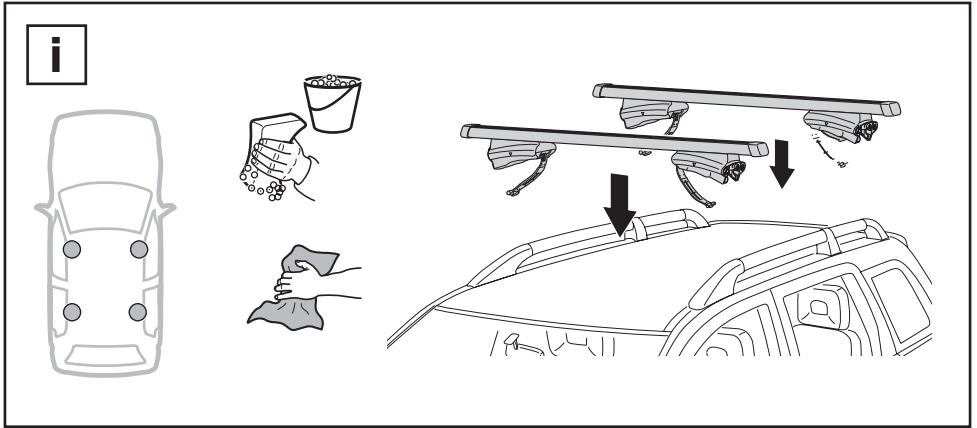

4

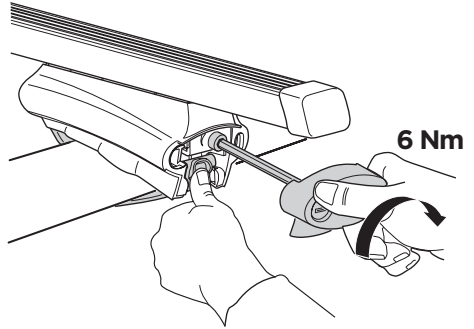
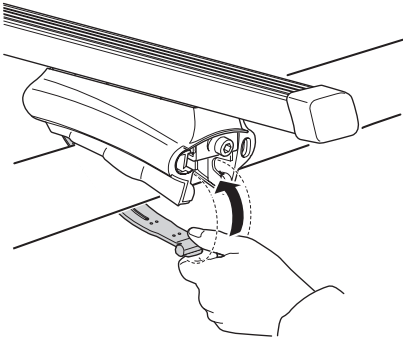

x1

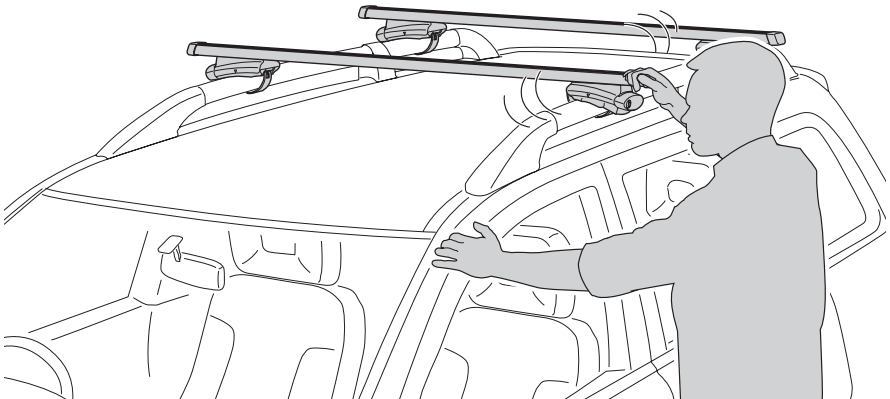
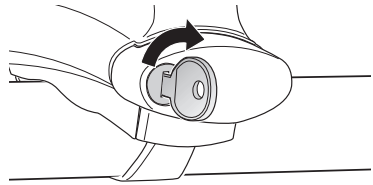
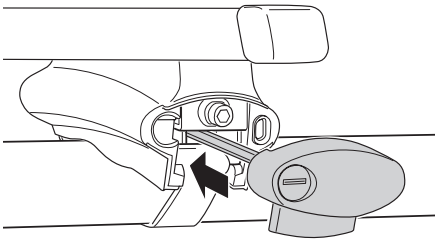

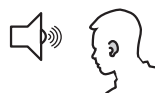

THULE WingBar

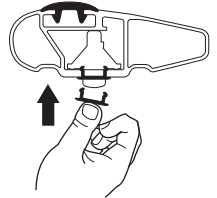
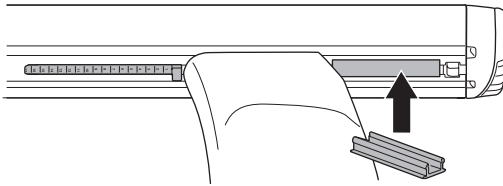
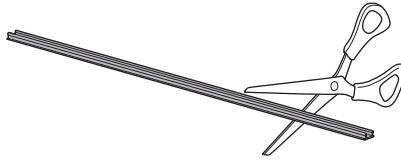
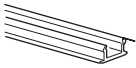

THULE SlideBar

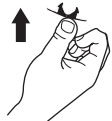
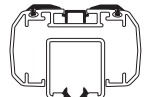
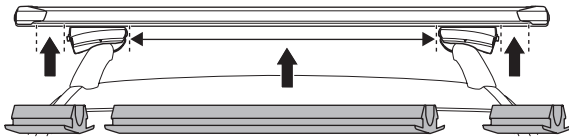
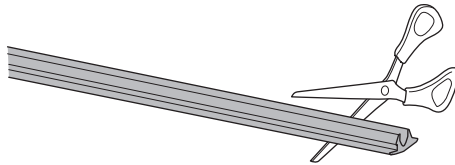
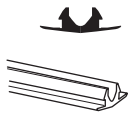

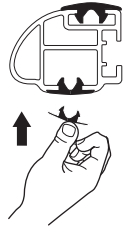
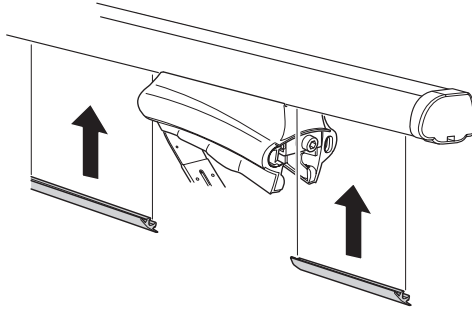
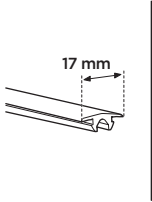
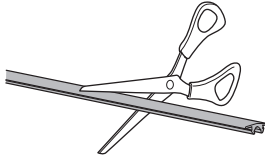



THULE WingBar

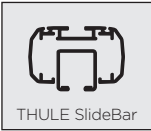
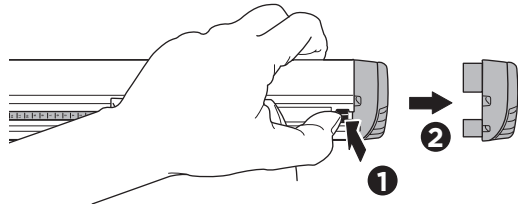
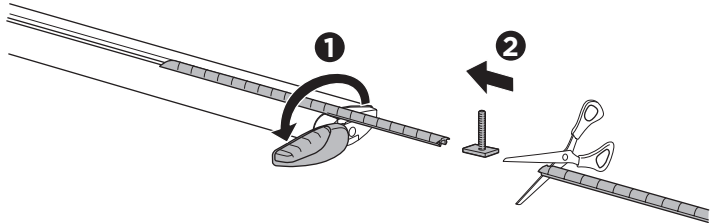

THULE SlideBar

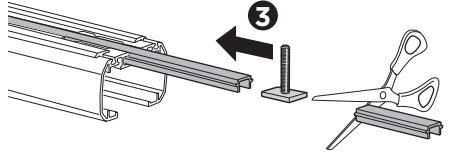
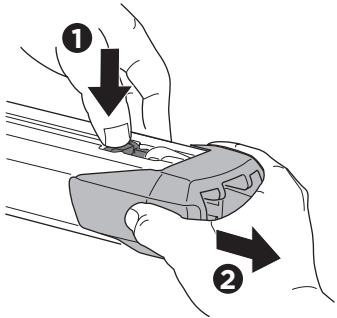



THULE ProBar

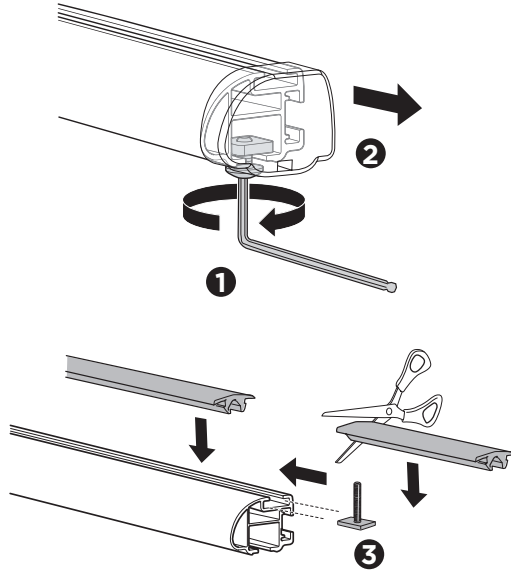

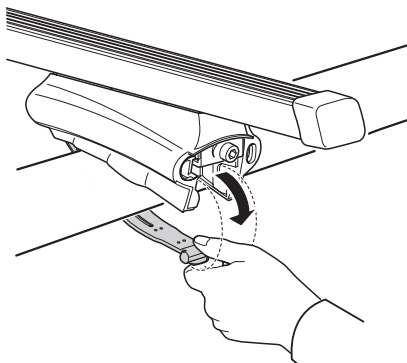
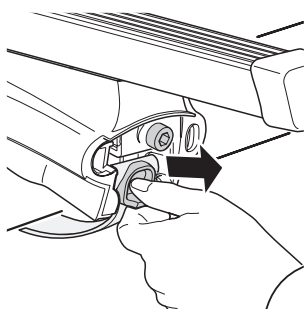
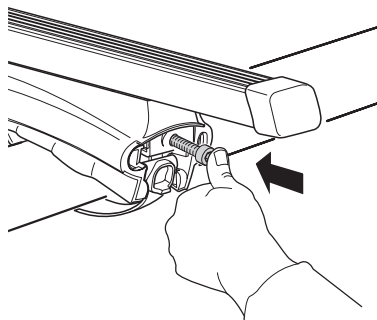
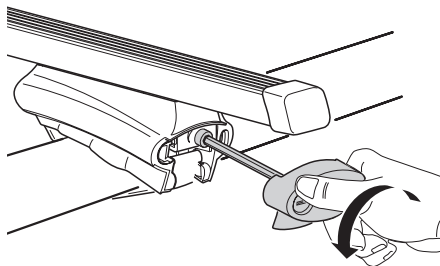
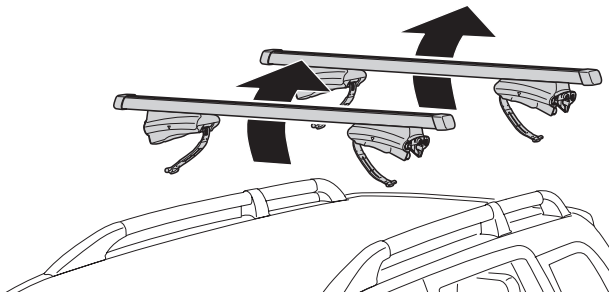

Thule One-Key System

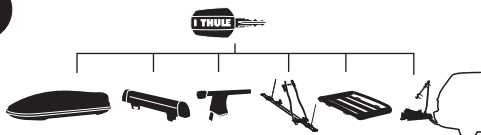

544  (x4)

596  (x6)

588  (x8)

452  (x12)