

2

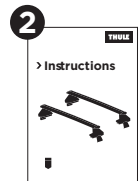

> Instructions

Thule Evo Clamp
710500

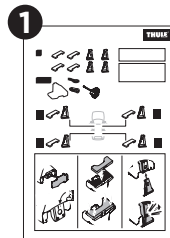
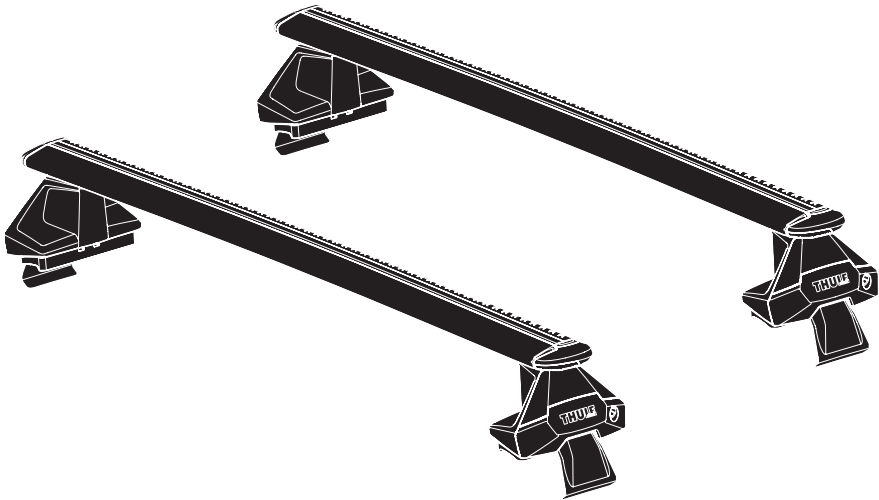

EN Roof mounted load carrier
DE Lastenträger zur Dachmontage
FR Barre de toit
NL Dakdrager
IT Barra portatutto da installare sul tetto
ES Portaequipajes de techo
PT Barra para montagem no tejadilho
SV Takmonterad lasthållare
DK Tagmonteret lastholder
NO Takmontert lasteholder
FI Katolle asennettava teline
ET Katusele paigaldatav katuseraam
LV Uz jumta uzstādāms kravas turētājs
LT Ant stogo tvirtinamas krovinų laikiklis
PL Uchwyt na bagażnik bazowy montowany na dachu
RU Багажник на крышу
UK Багажник для даху
BG Багажник, монтиран върху покрива
CS Nosič pro montáž na střechu
SK Strešný nosič
SL Nosilec za strešni prtljažnik
HR/BIH Krovni nosač tereta

RO Suport încărcătură montat pe acoperiș
HU Tetőre szerelhető csomagszállító
EL Σχάρα οροφής για μεταφορά φορτίου
TR Araç üstüne bağlanan yük taşıyıcı
 מנשא מטען לגג הרכב **HE**
 حامل نقل مثبت على السقف **AR**
ZH 顶置行李架
JA ルーフマウント型ロードキャリア
KO 루프 장착 화물 캐리어
TH โครงยึดของบรรทุกแบบติดตั้งบนหลังคา

CITY CRASH
Complies with ISO norm

ISO 11154-E

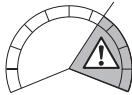
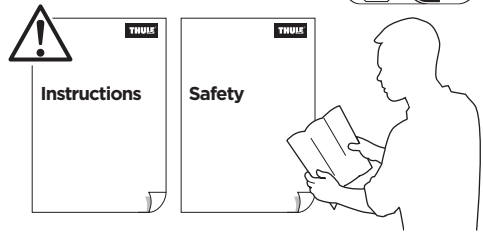

Max 130 km/h
80 Mph



Your Key-Number

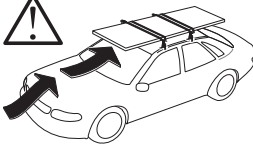

80 km/h
50 Mph

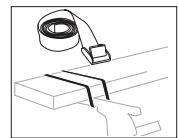
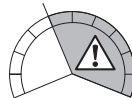

> Mounting Tutorial

Thule Evo Clamp

THULE
SWEDEN



thule.com

1
KIT

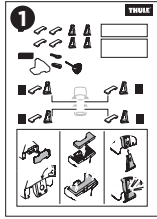

+

2
FOOT PACK

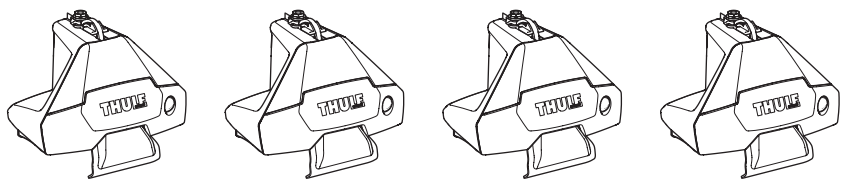
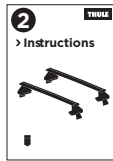

3
BAR

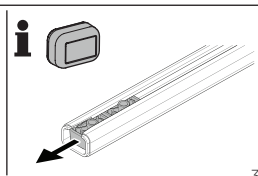
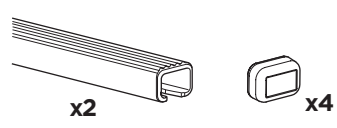
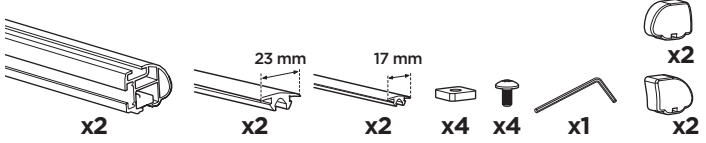
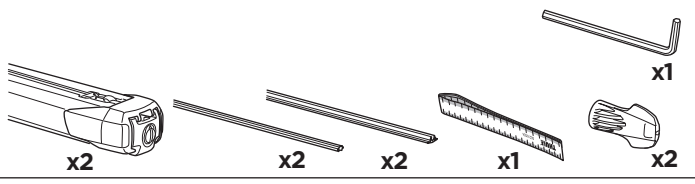
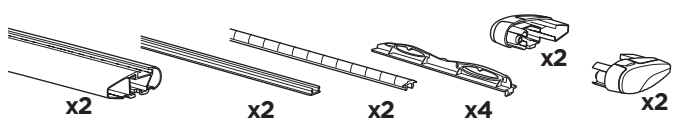
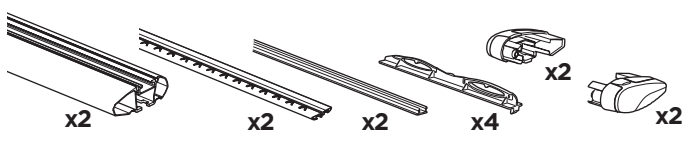



A

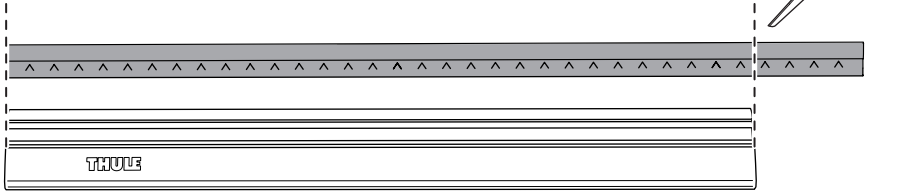

B

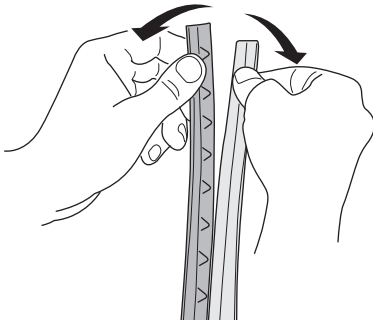

C

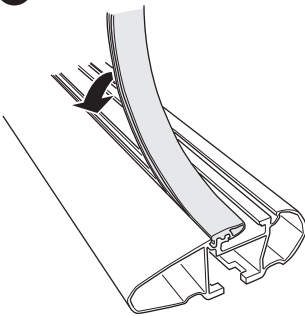

D

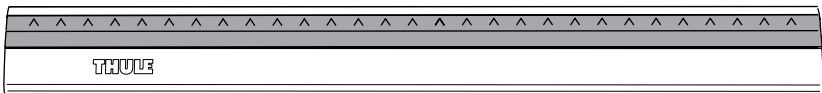
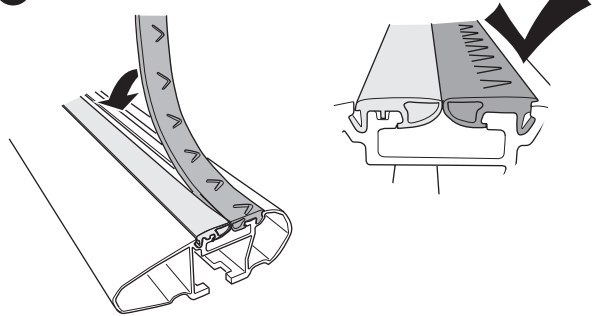

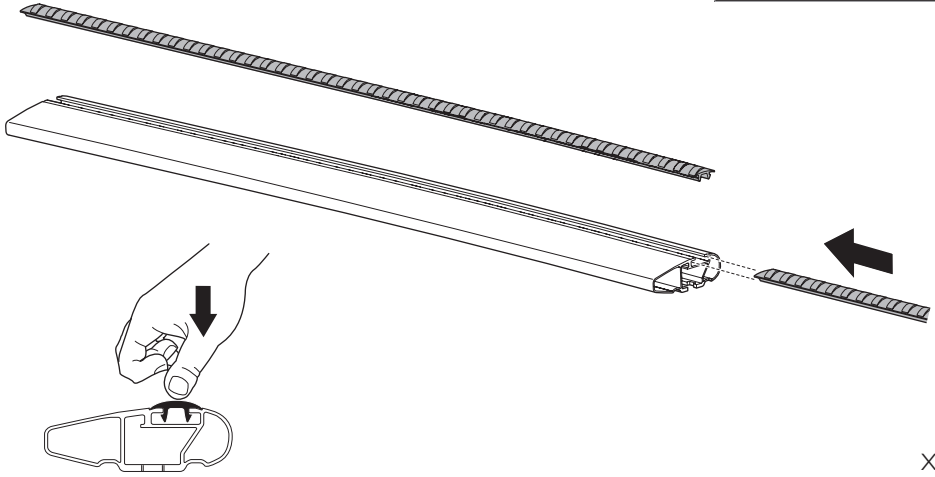

5



A



B



C

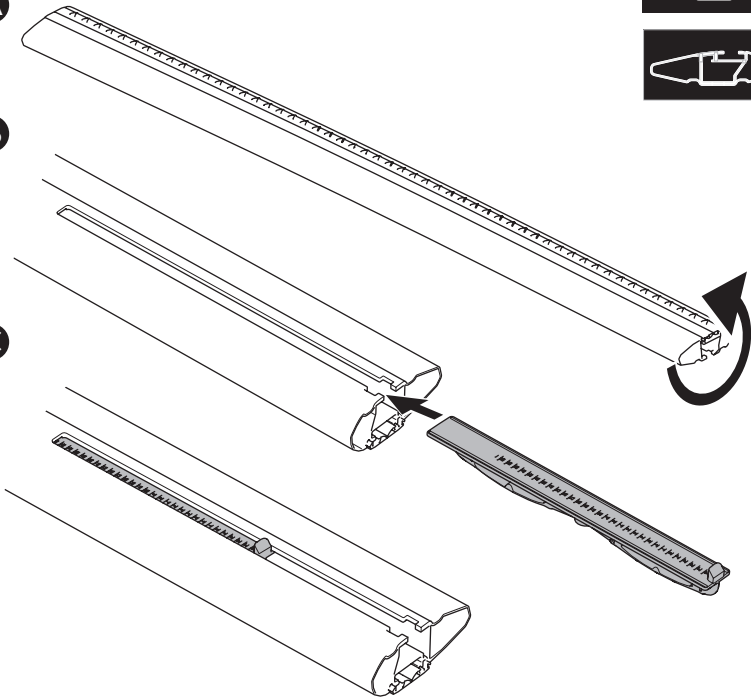

6

1 KIT + **2** FOOT PACK + BAR **3**

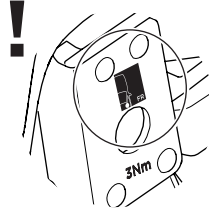
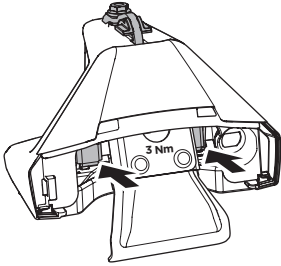

A

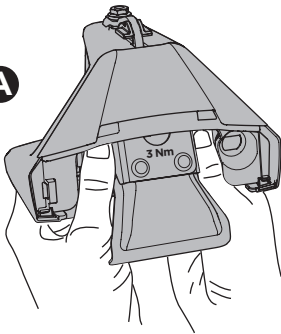

B

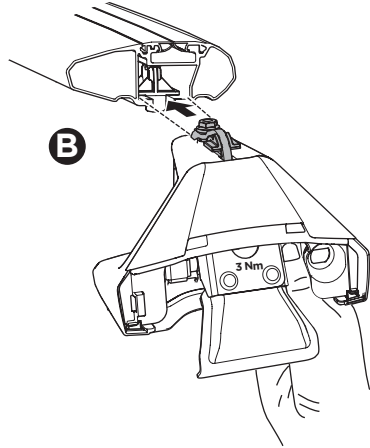

x4

7

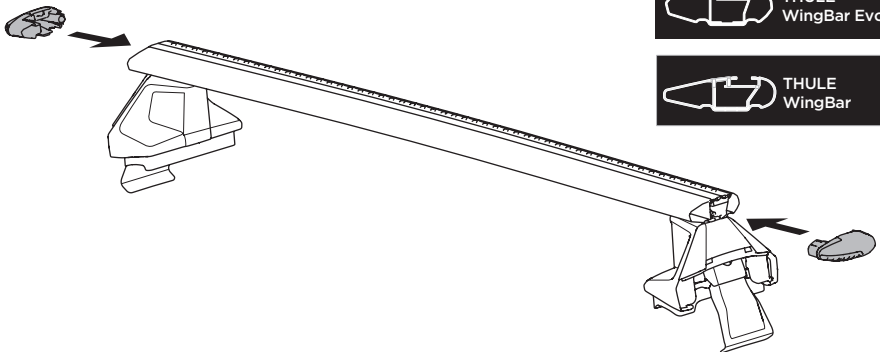

THULE
WingBar Evo

THULE
WingBar

x2

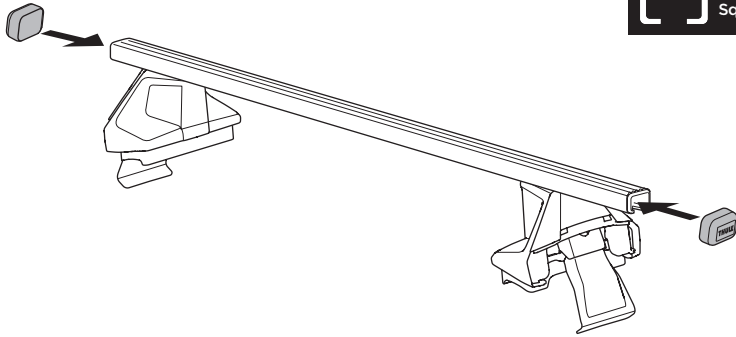

x2

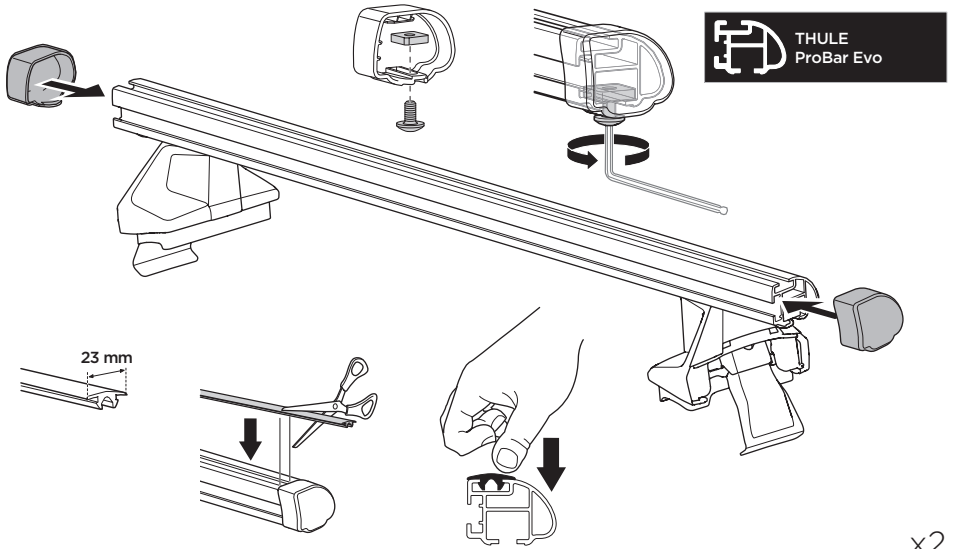

x2

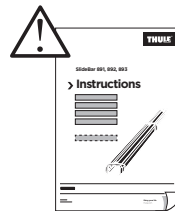
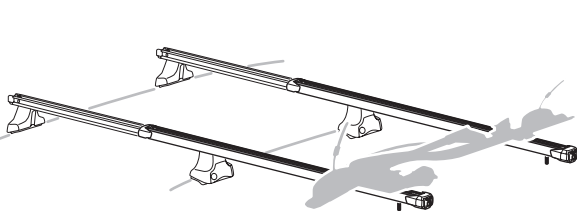

8

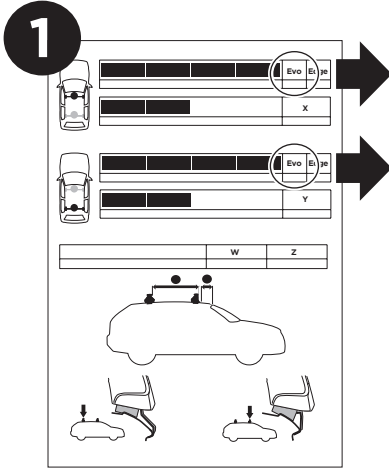
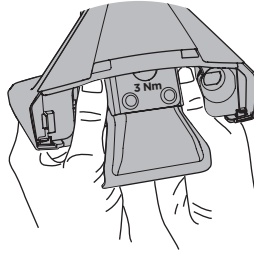

X / Y Scale

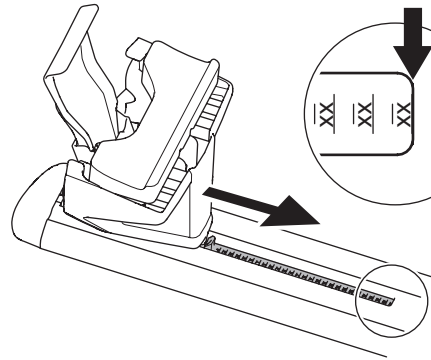
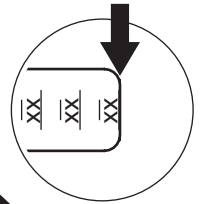

x4

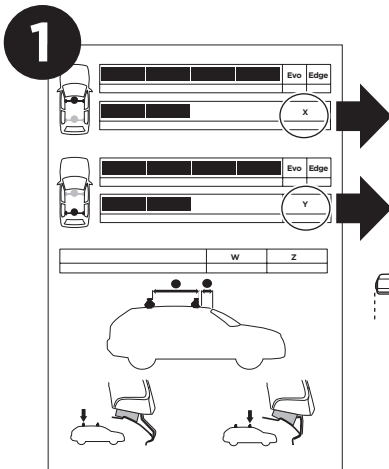
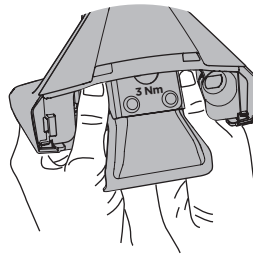

X / Y (mm / inch)

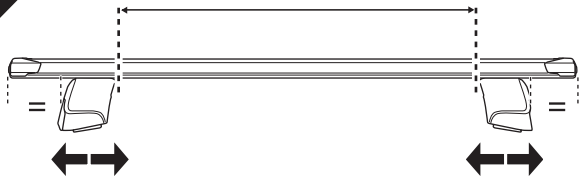

x2

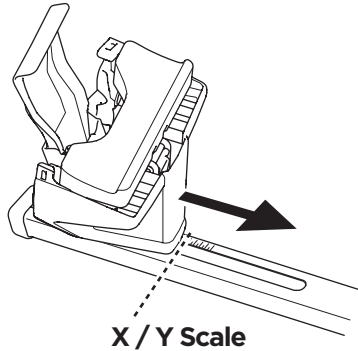
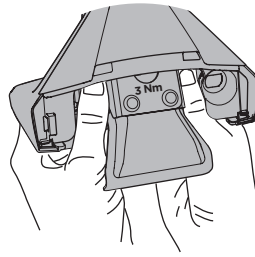
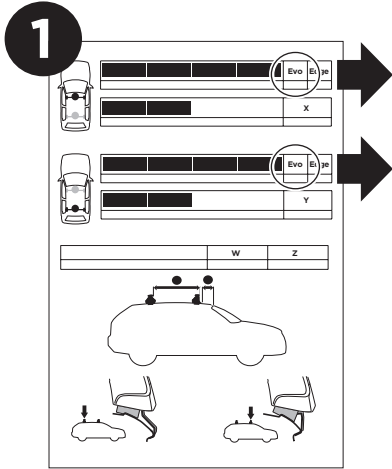

x4

9

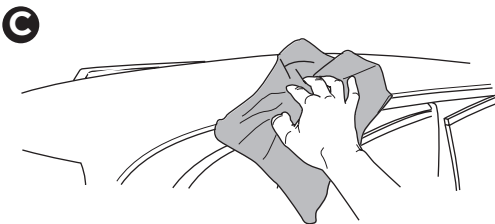
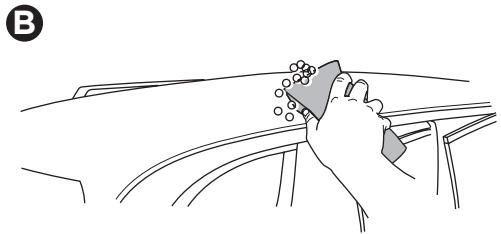
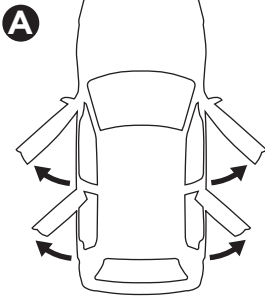

10

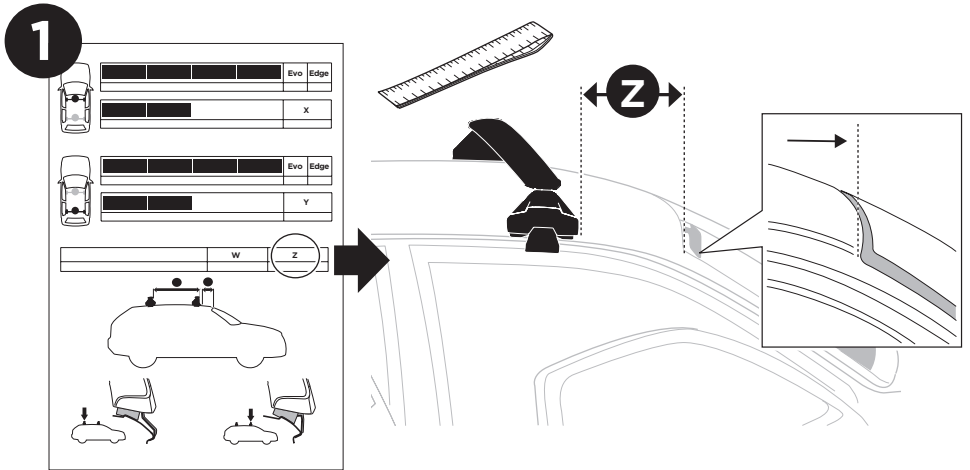
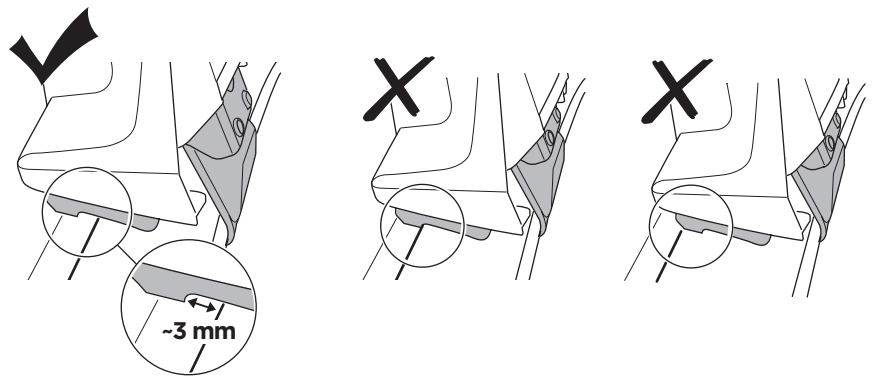
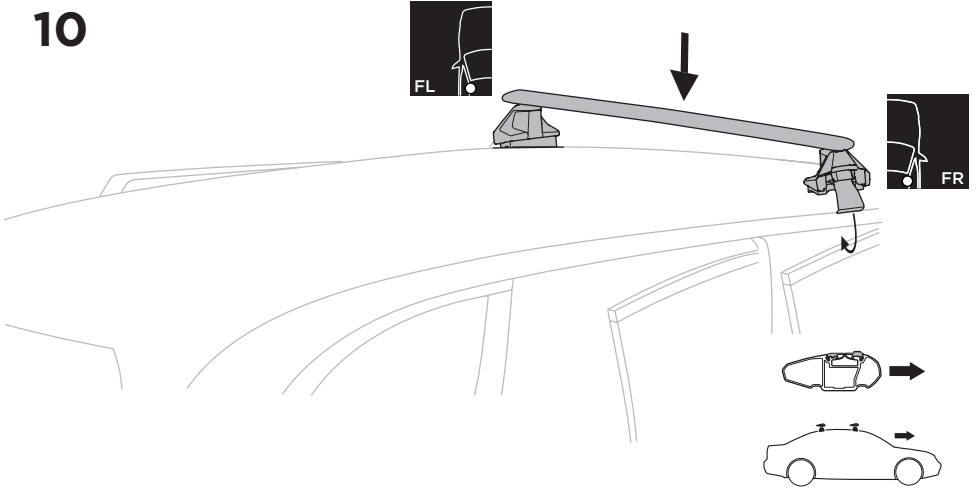

1

	Evo	Edge
	X	
	Evo	Edge
	Y	
	W	Z

11

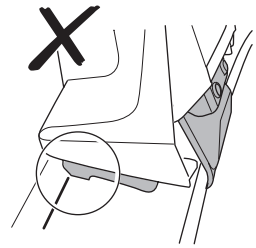
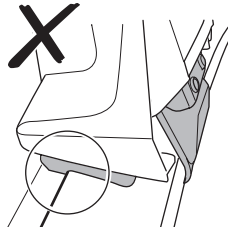
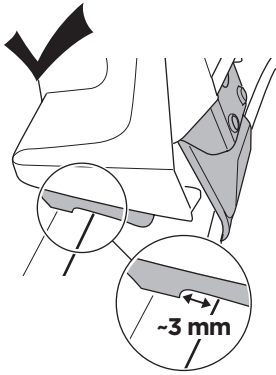
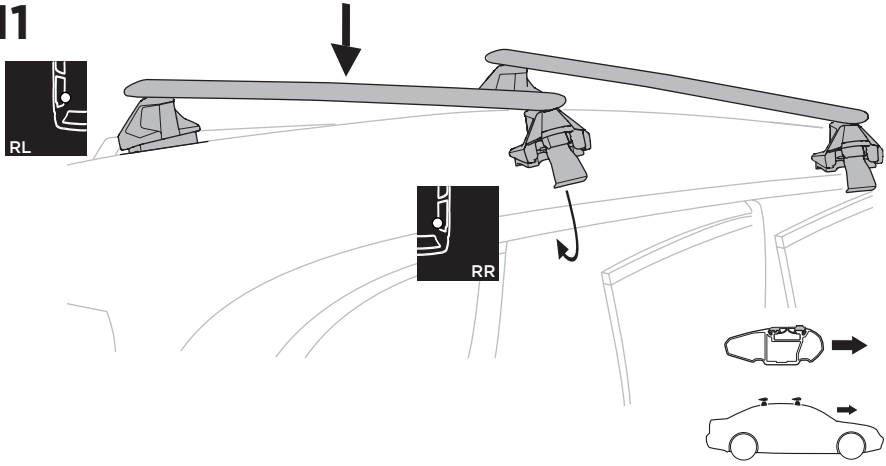

1

	Evo	Edge
	X	
	Evo	Edge
	Y	

W Z

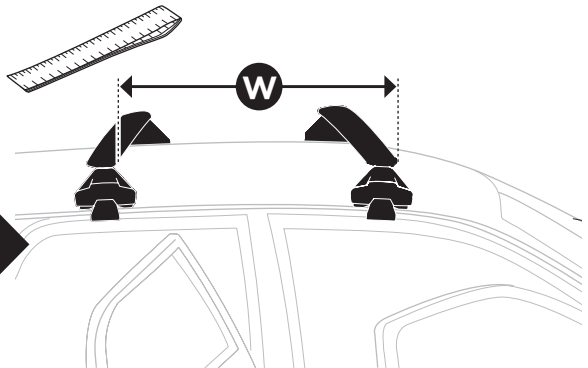

12

-50%

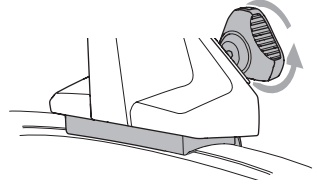
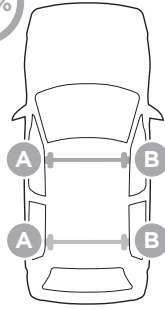
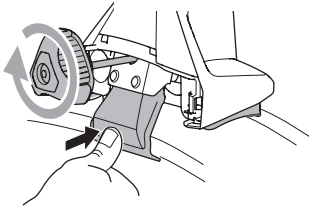

100%

Click
Click

3 Nm

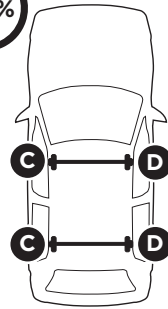
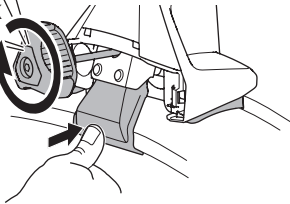

Click
Click

3 Nm

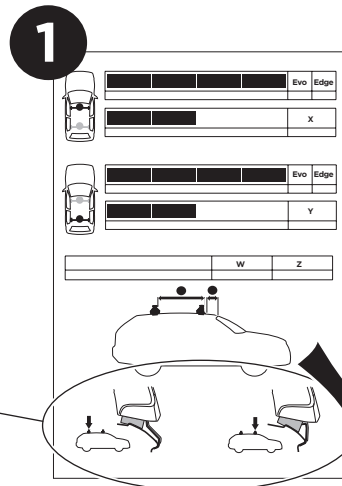
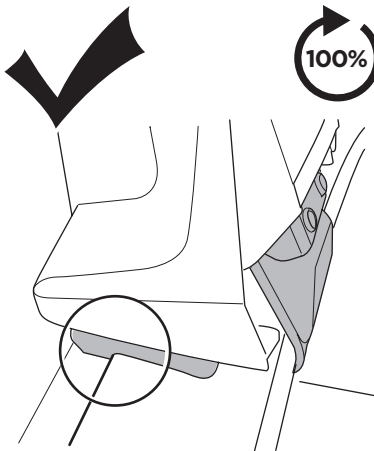
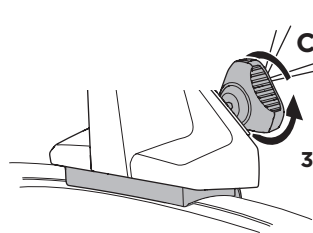

13

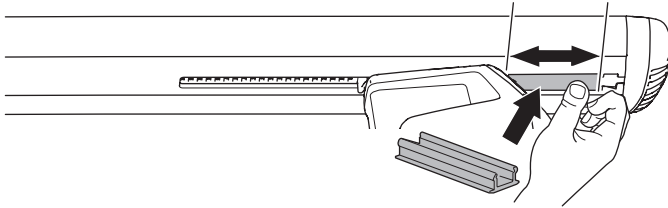
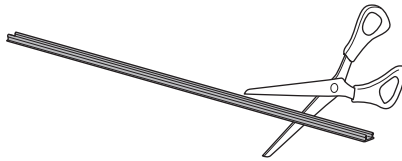

x4

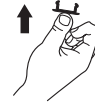
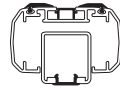
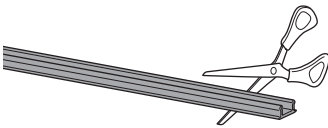
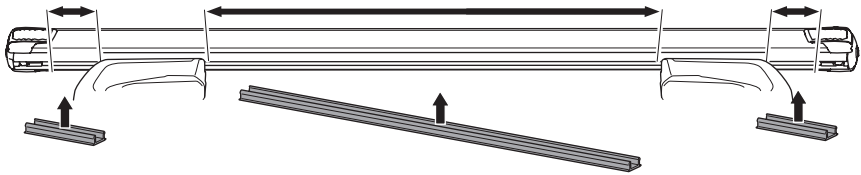

x2

17 mm

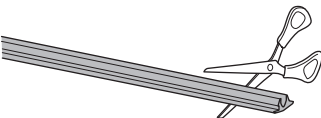
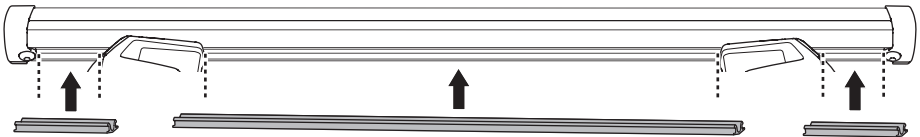
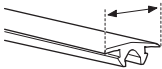

x2

14

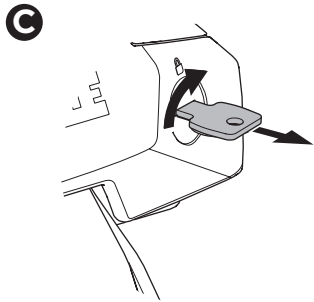
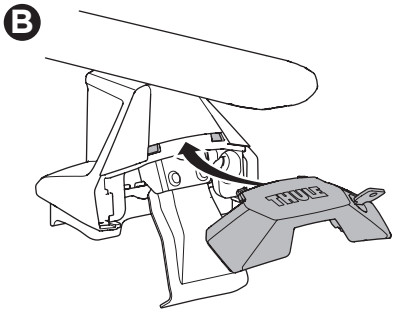
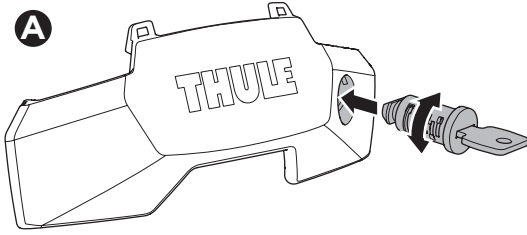

x4

15

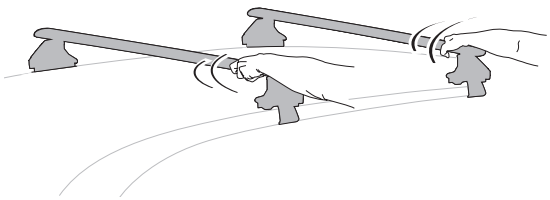
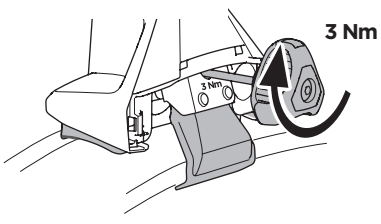
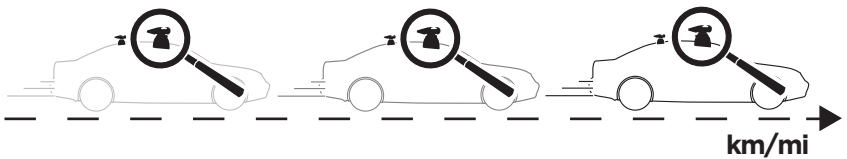
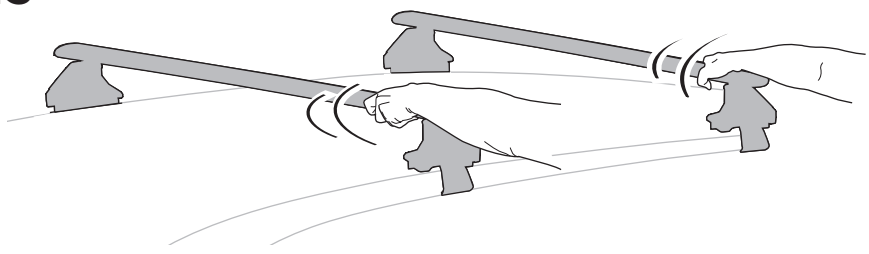

i



THULE
WingBar Evo

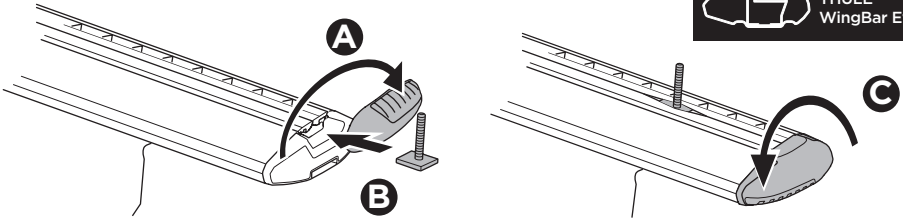

THULE
WingBar

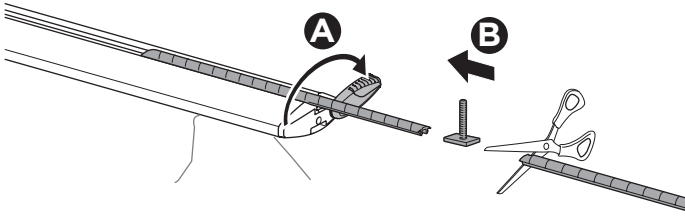

THULE
SlideBar Evo

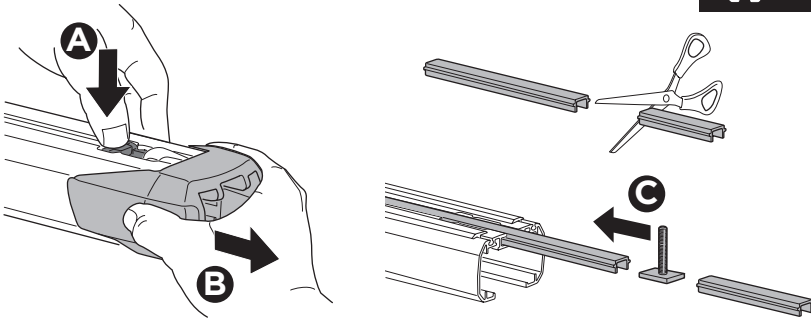

THULE
ProBar Evo

