

Thule Touring

➤ **Instructions**

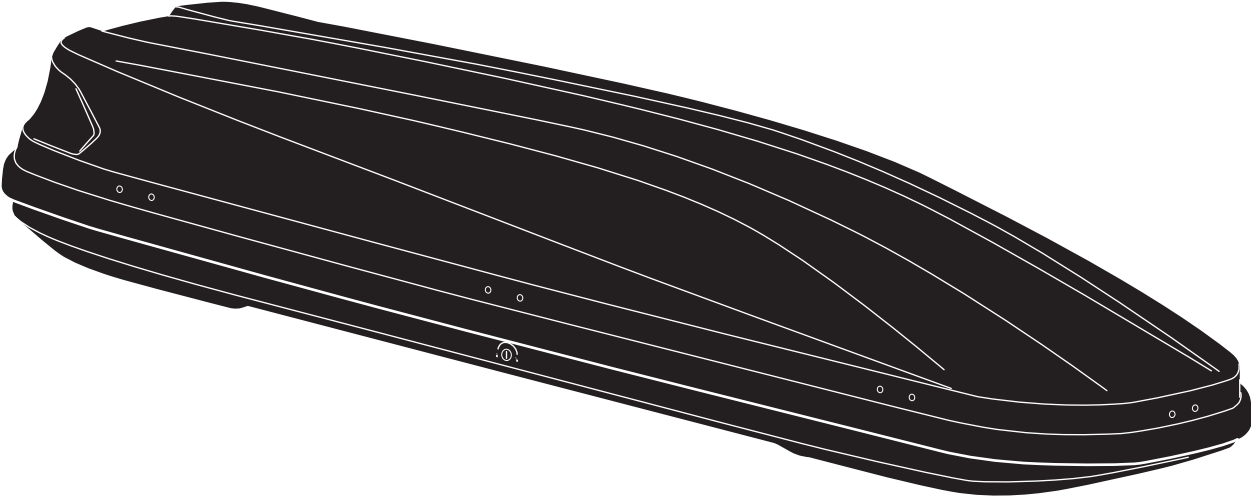

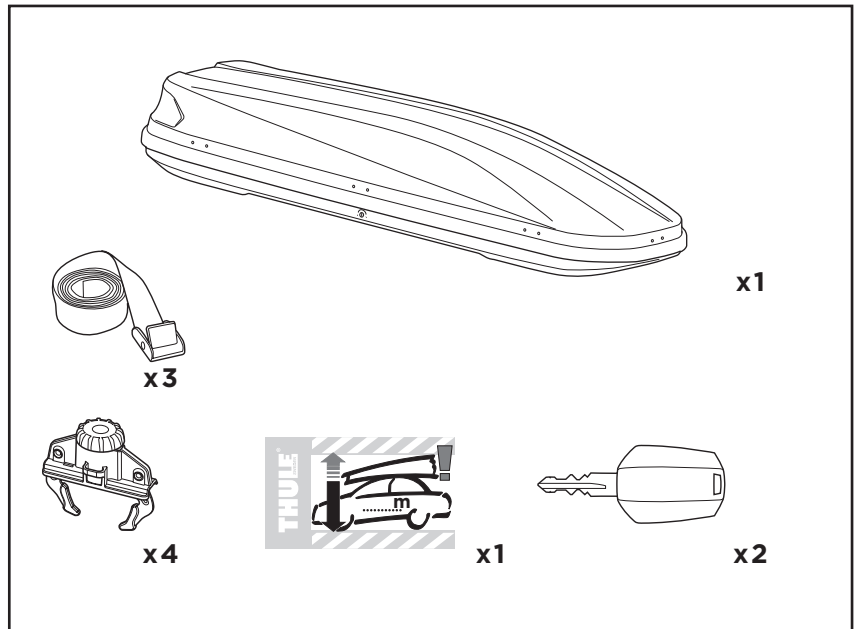
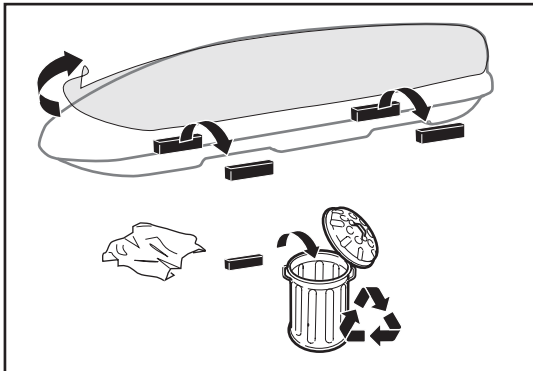
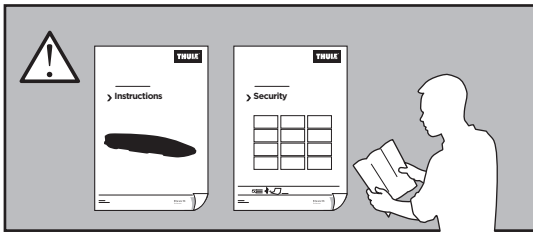

1

i Thule T-track adapter

696400

697400

Diagram showing the installation of the T-track adapter on a car roof. The adapter is shown being inserted into the T-track. The diagram includes dimensions for the adapter's fit:

- Max 90 mm (width)
- Min 18 mm (height)
- Max 38 mm (height)

Two sets of dimensions are shown, corresponding to different car models:

- Touring 100: Min 515 mm, Max 925 mm
- Touring 200, 600, 700, 780: Min 545 mm, Max 955 mm

2

Diagram showing the installation of the surfboard rack on a car roof. The rack is shown being placed on the roof rails. The diagram includes a key icon and a lock icon, indicating that the rack is secured with a key.

3

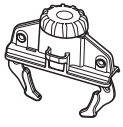

x4

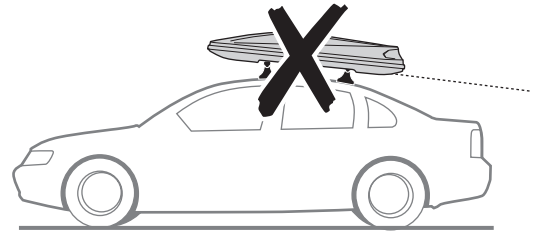
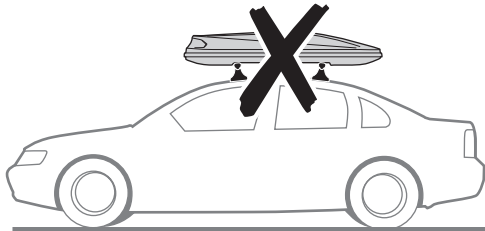
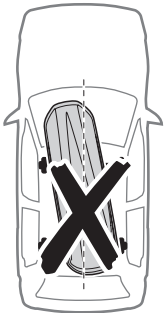
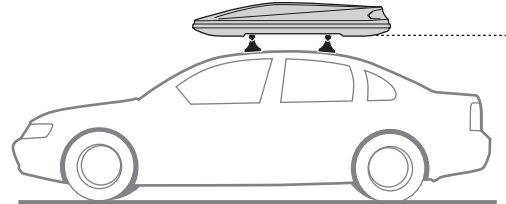
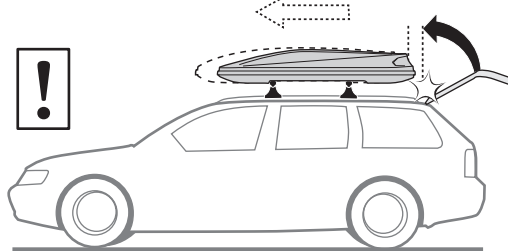
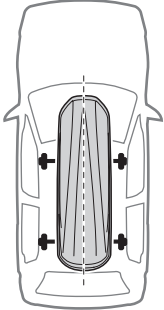
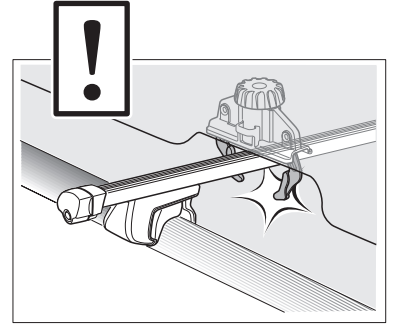
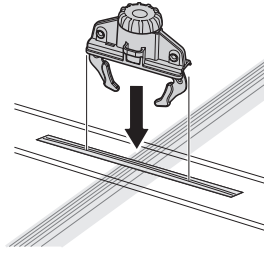
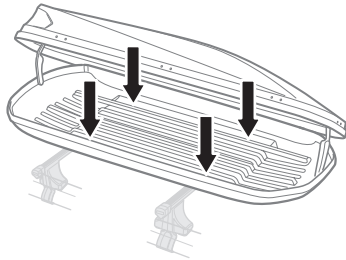

4

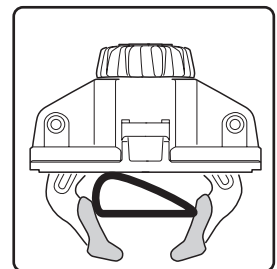
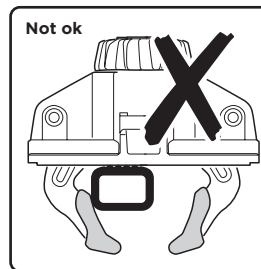
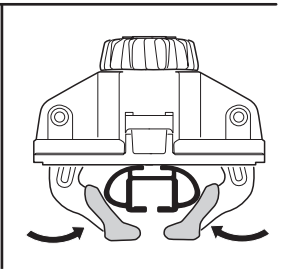
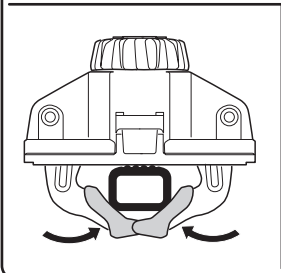
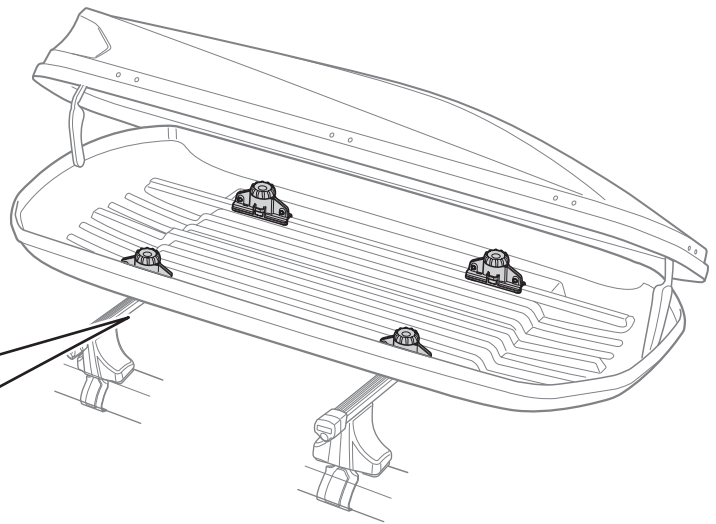
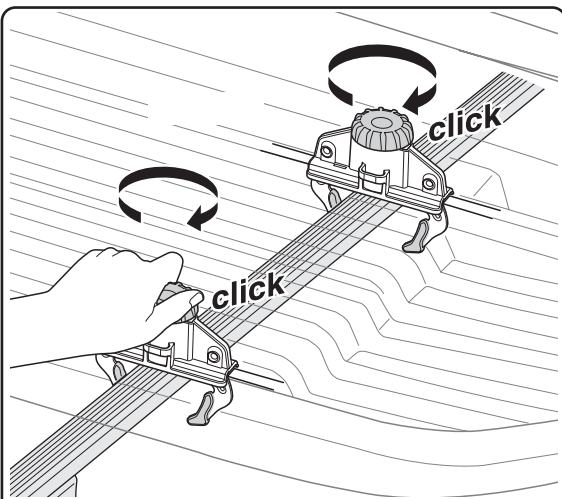

5

Touring 100

Touring 200
Touring 600
Touring 700
Touring 780



x3

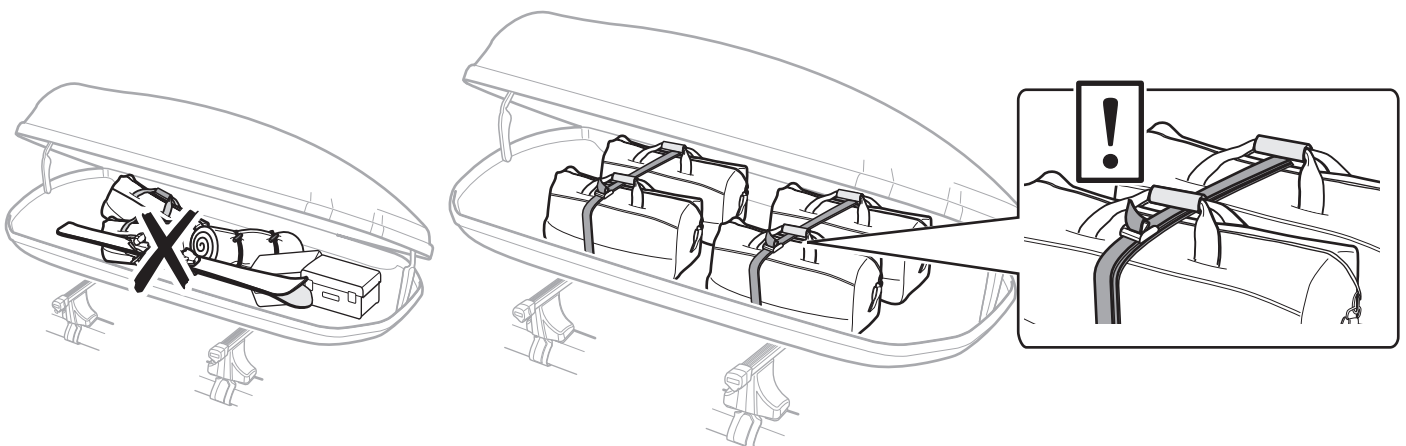
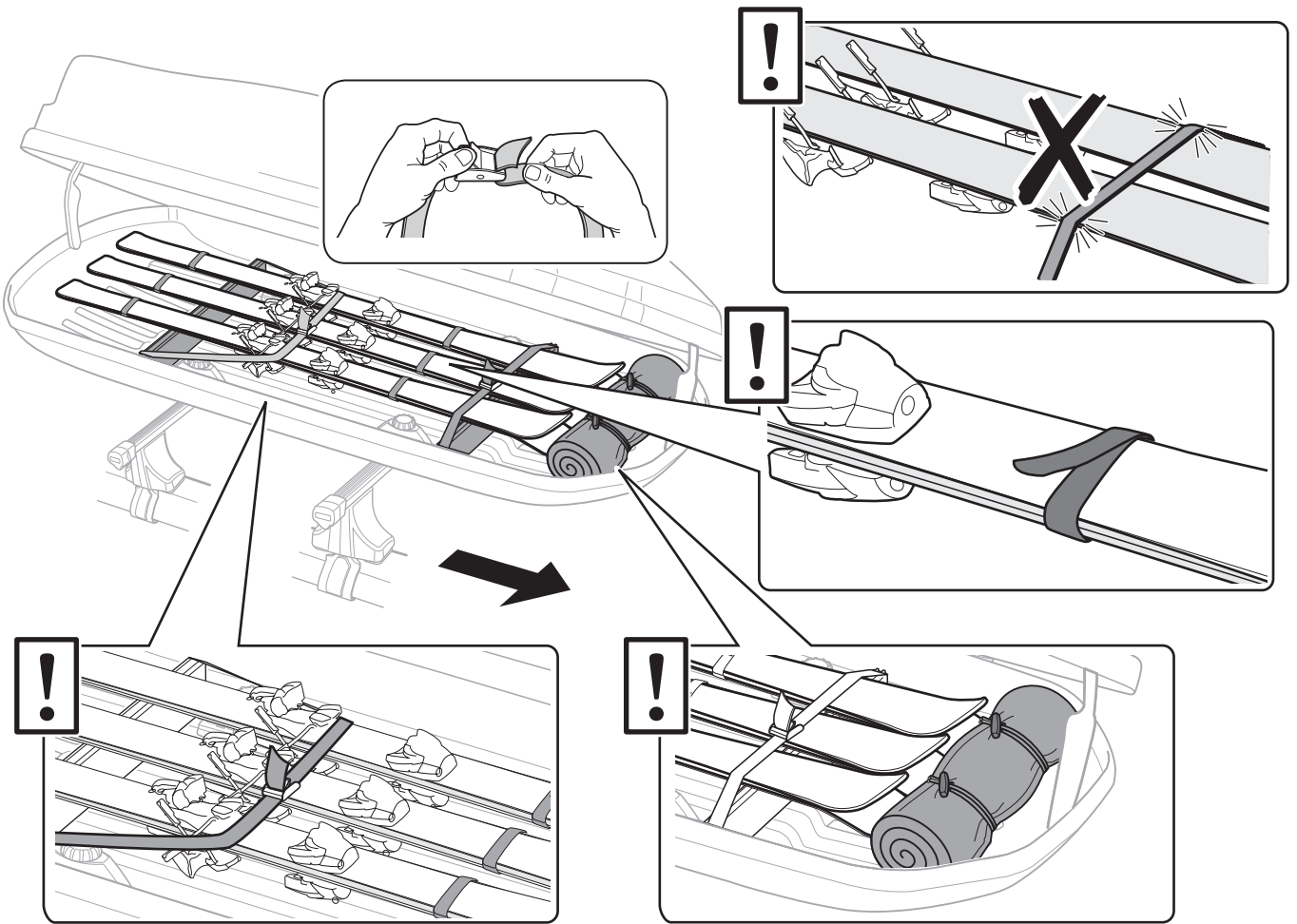
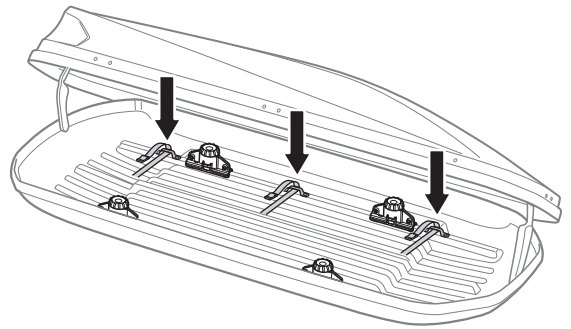
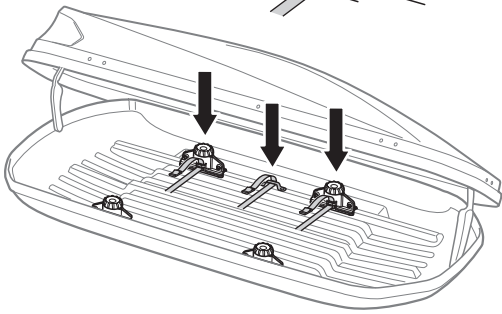
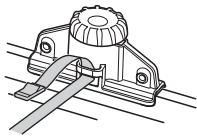

6

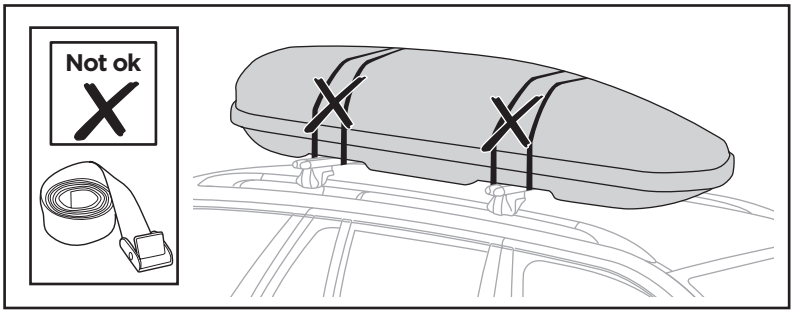
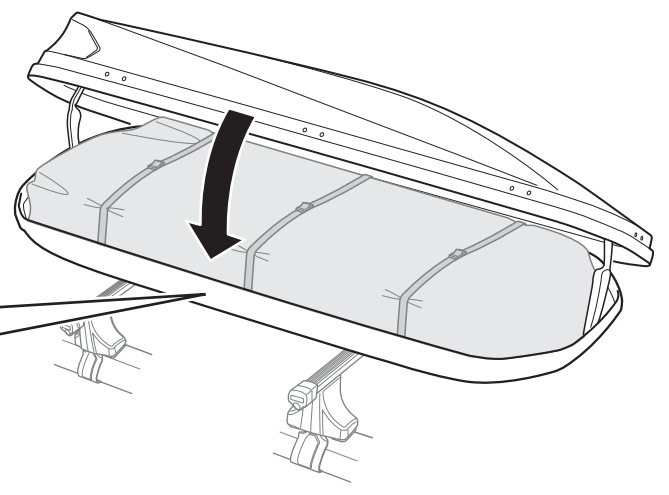
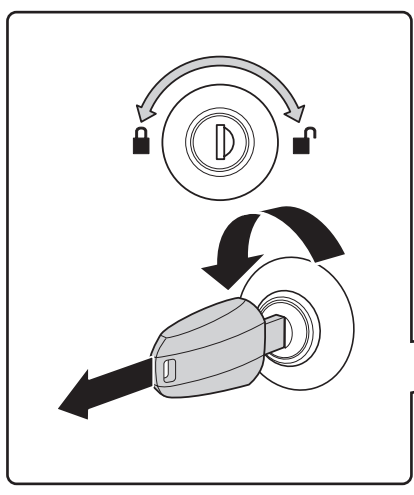

7

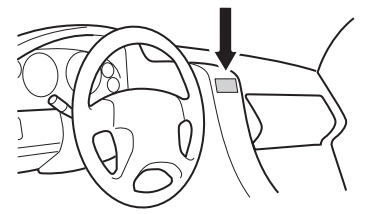
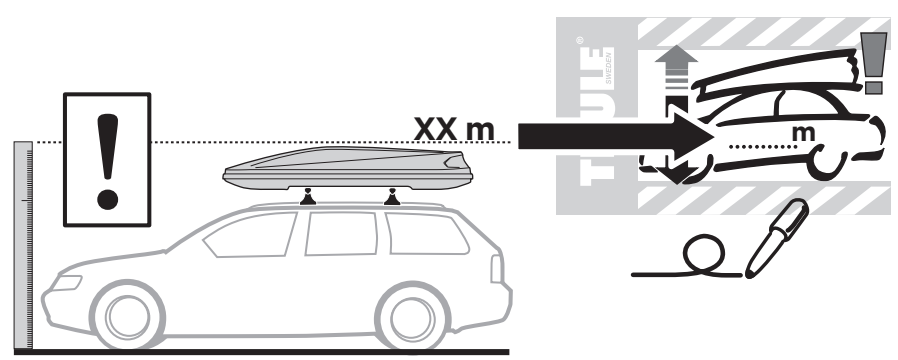
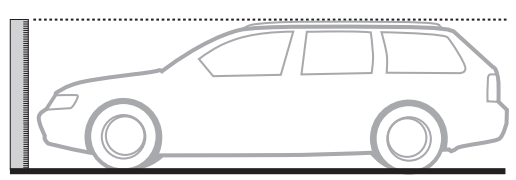
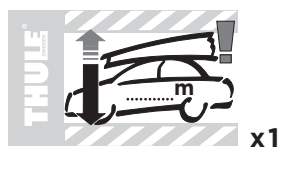

i Thule T-track adapter

696400 → 24x30 mm

697400 → 20x27 mm

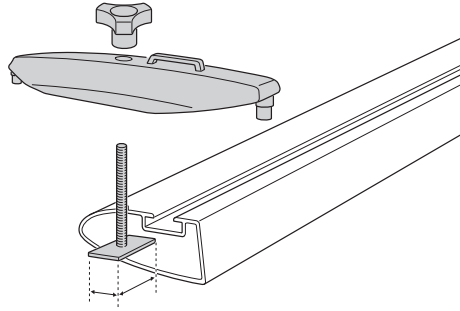

i Thule Boxlift

571000

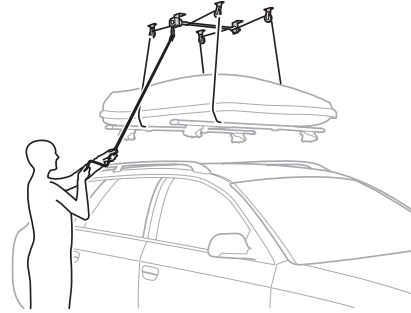
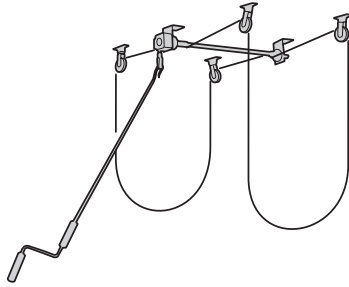

i Thule Box Ski Carrier adapter

694800 → Touring: 200, 780

694600 → Touring: 600

694700 → Touring: 700

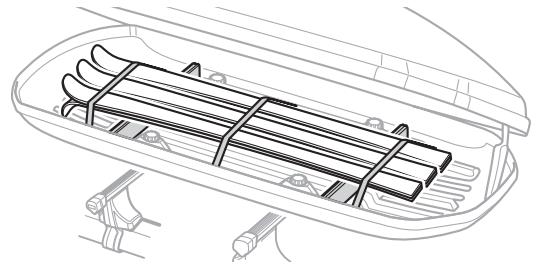
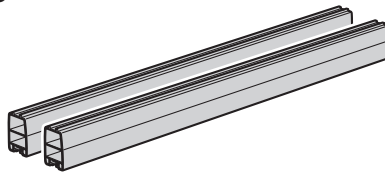

i Thule Box light

695100

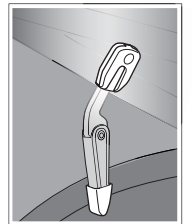
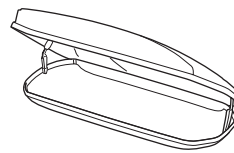
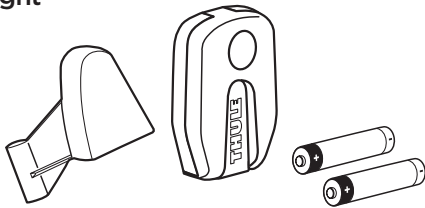

i Thule Lid protection cover

698100 → Touring: 100, 200, 780

698200 → Touring: 600, 700

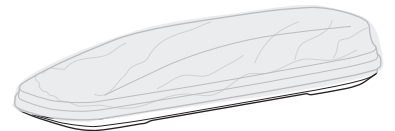
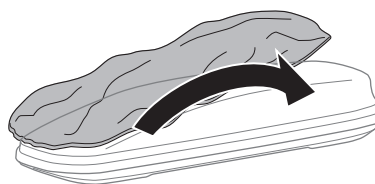

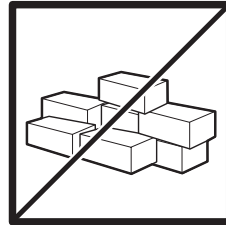
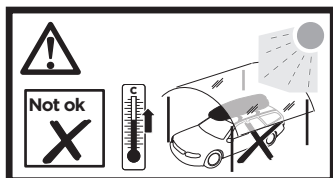
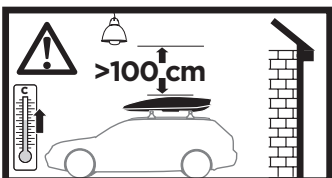
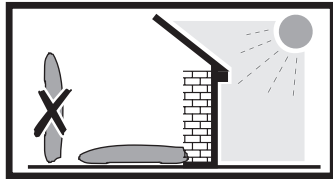
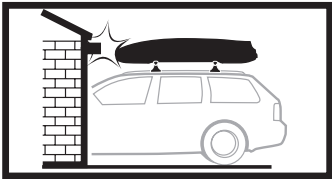
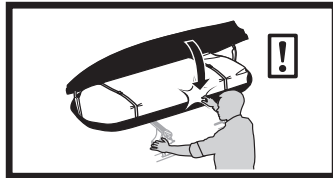
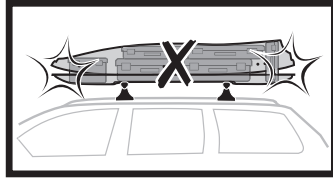
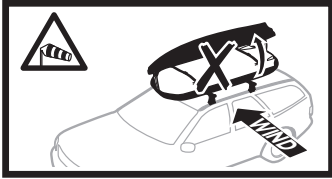
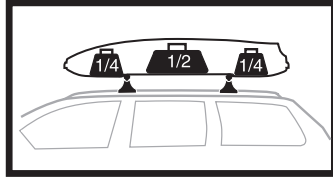
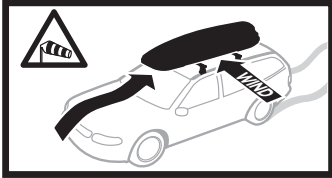
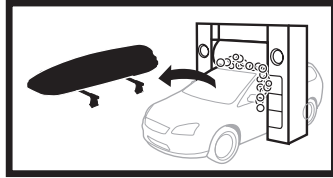
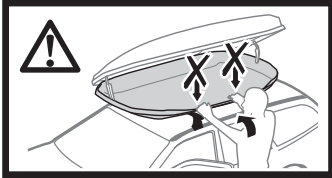

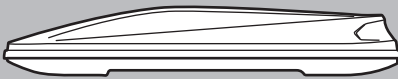

Touring 100: 10 kg
Touring 200: 13 kg
Touring 600: 12 kg
Touring 700: 15 kg
Touring 780: 15 kg

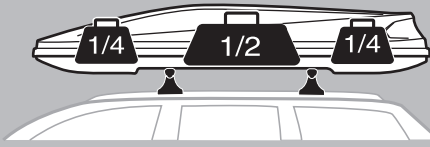



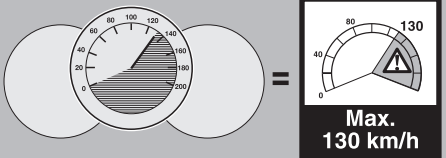

Max 50 kg

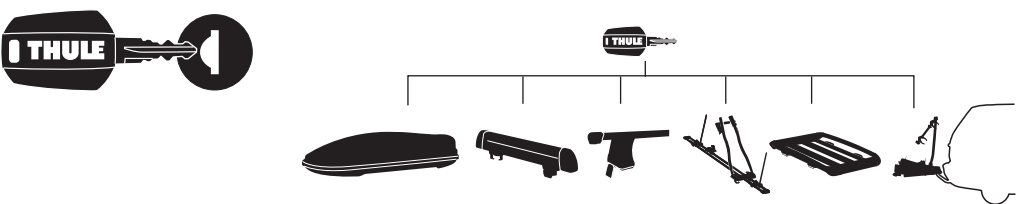

Max. 130 km/h

Thule One-Key System



- 544**  (x4)
- 596**  (x6)
- 588**  (x8)
- 452**  (x12)

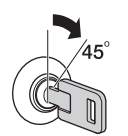
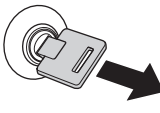
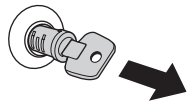
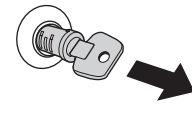
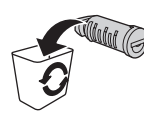
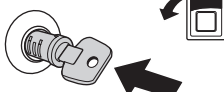
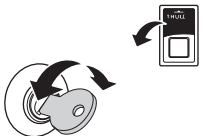

- 1** 
- 2** 
- 3** 
- 4** 
- 5** 
- 6** 
- 7** 
- 8** 