

**THULE**<sup>®</sup>  
SWEDEN

**Thule Motion XT 6292 6296 6298 6299**

# ➤ Instructions

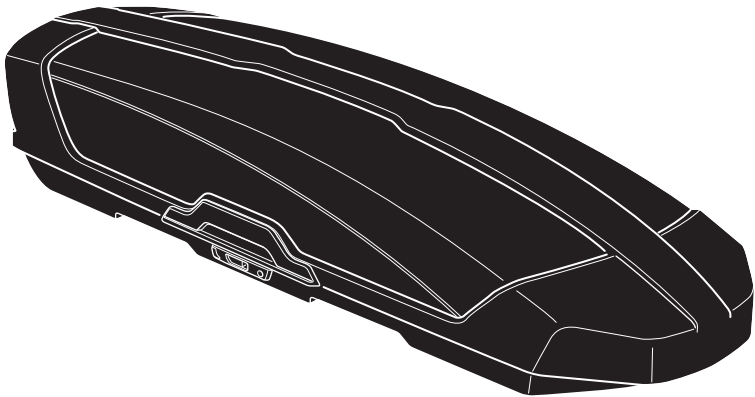

Roof box



**CITY CRASH**  
Complies with ISO norm

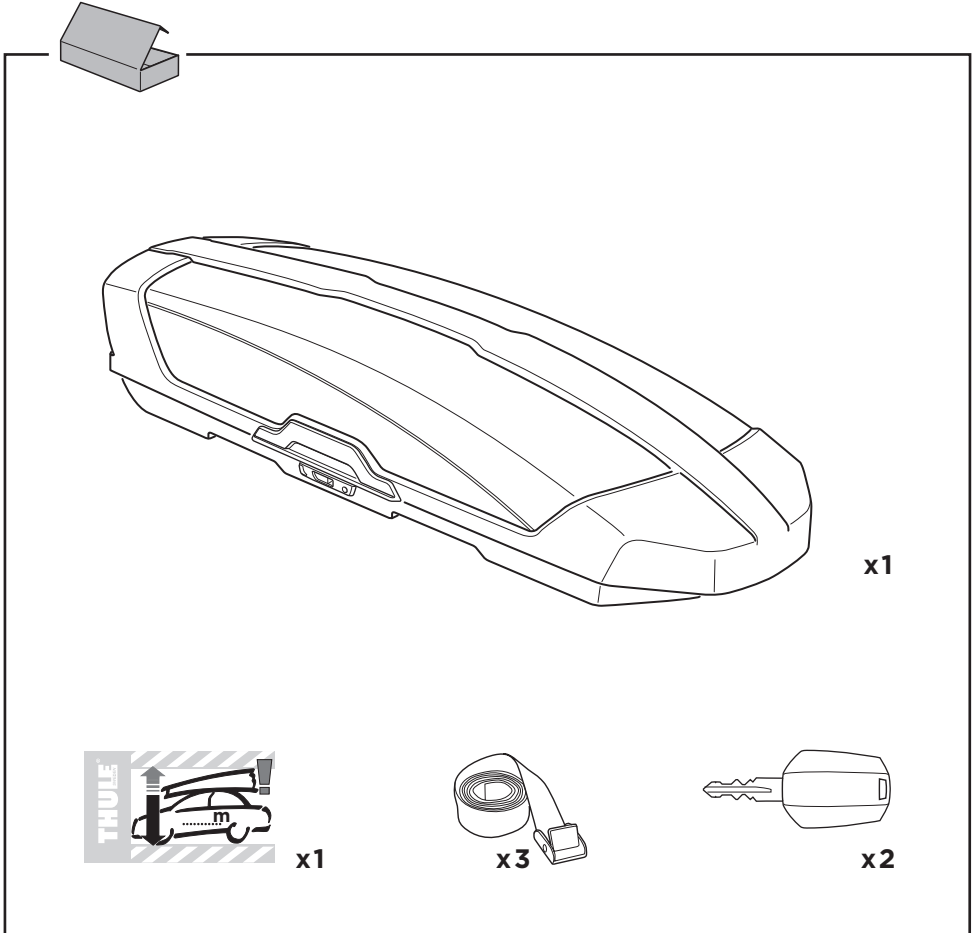
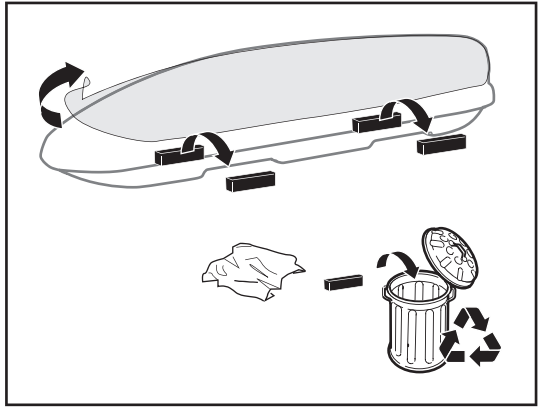

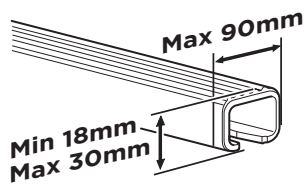
**i**

### Thule T-track Adapter

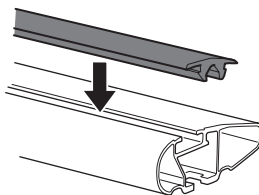
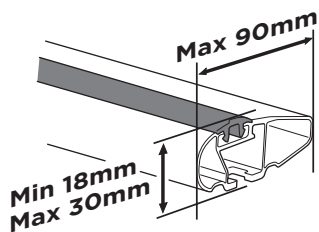
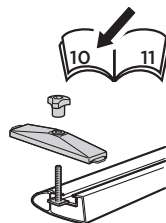
**696600**
**697600**

	D Min*	D Max*	W in*	W out*	H*	R Min*
M	560	930	755	865	460	450
Sport	560	930	565	675	430	500
XL	560	930	805	915	440	600
XXL	560	930	840	950	470	690



\*mm

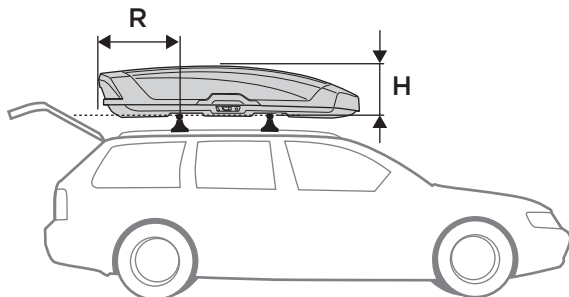
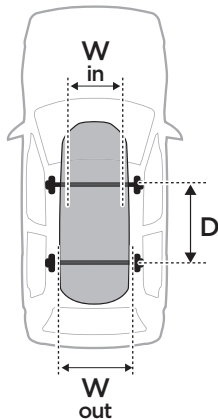

1

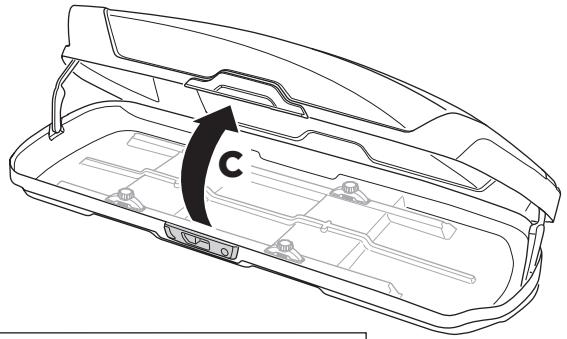
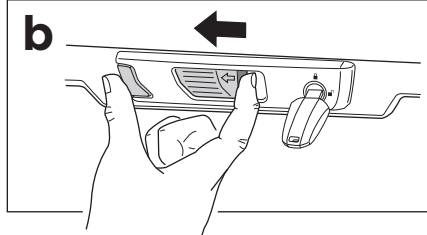
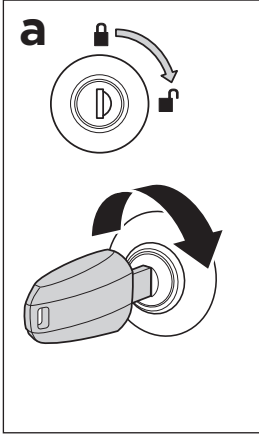

2

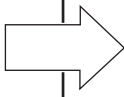
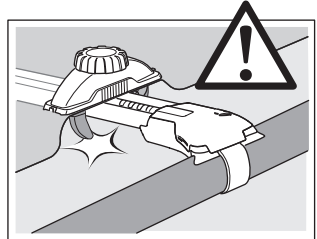
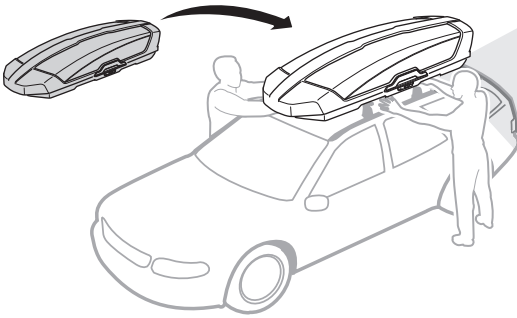
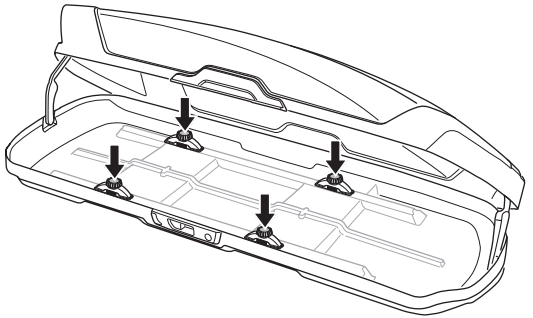
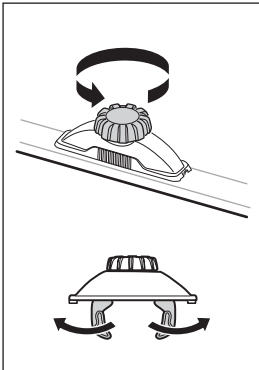

3

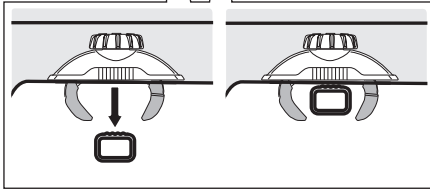
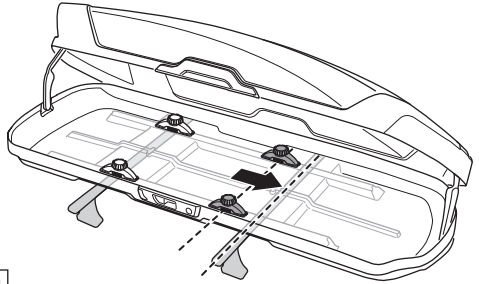
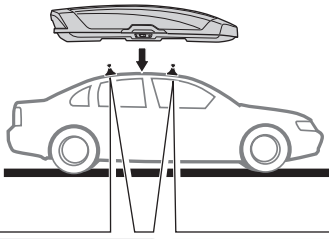
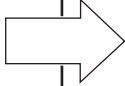

4

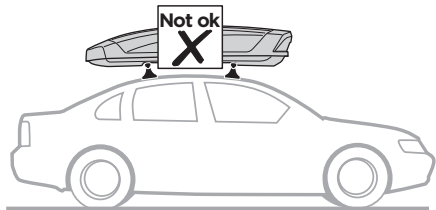
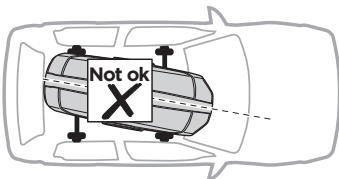
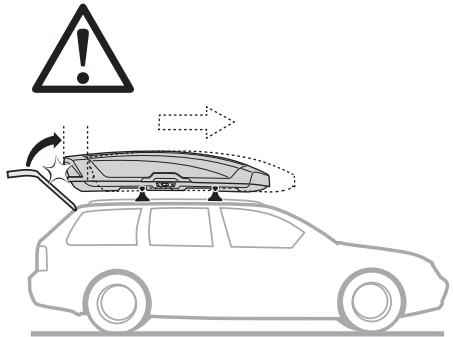
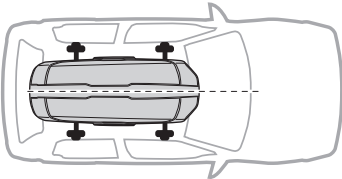

5

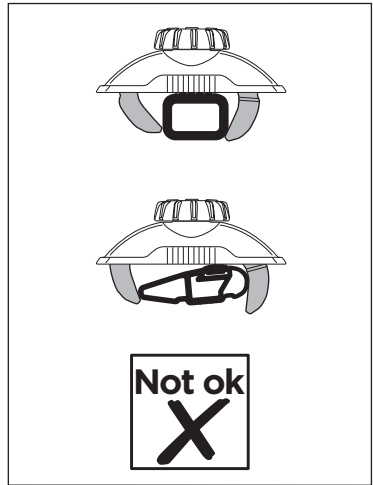
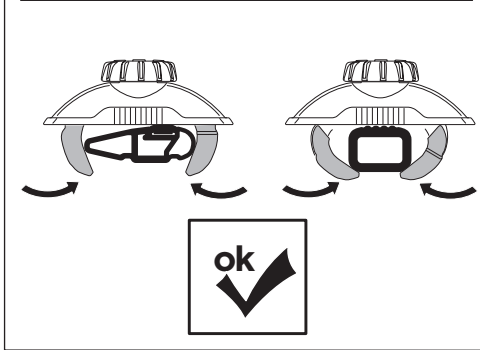
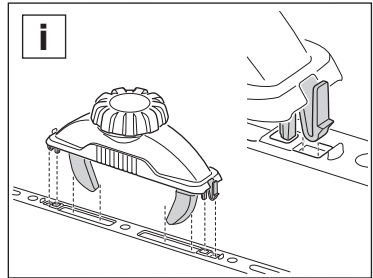
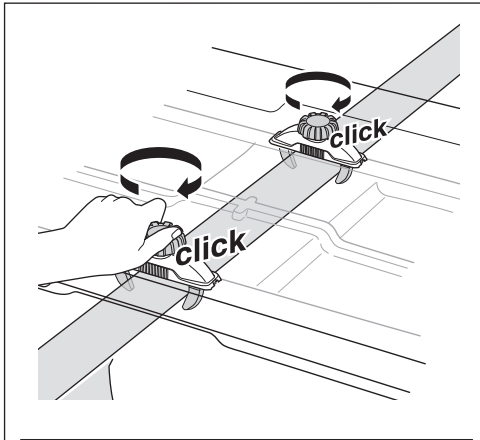
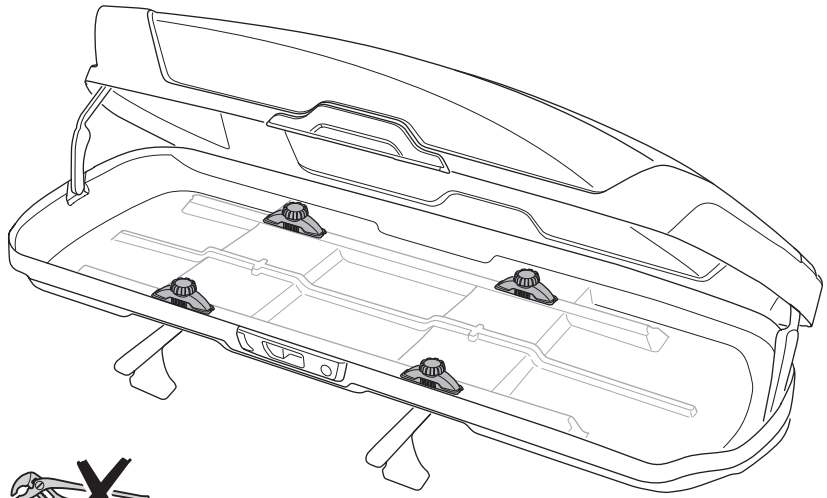

6

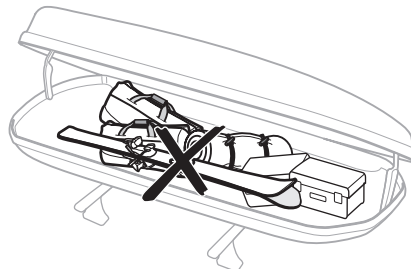
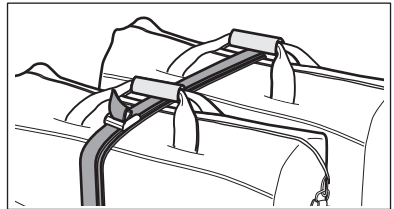
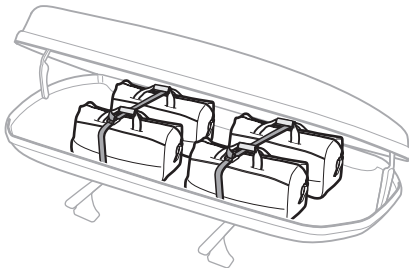
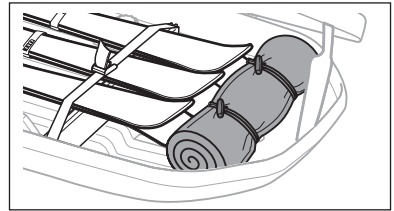
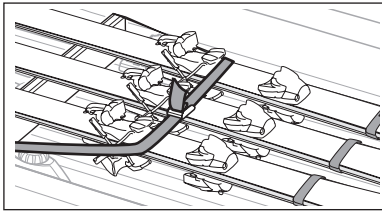
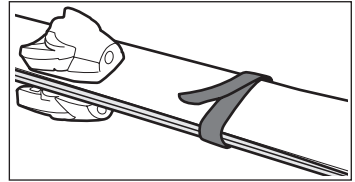
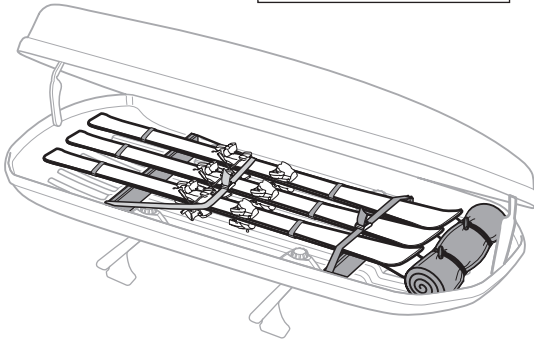
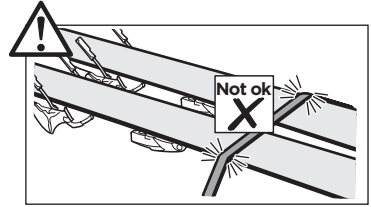
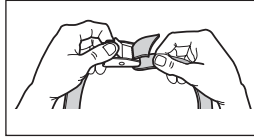

7

a

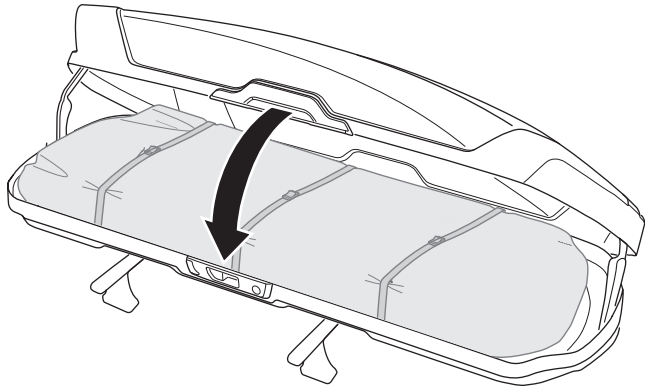

b

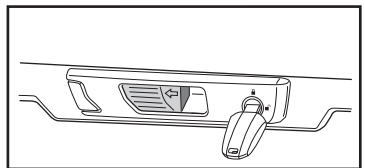
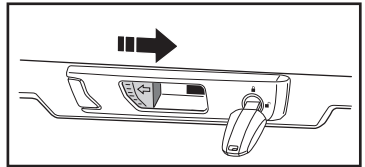
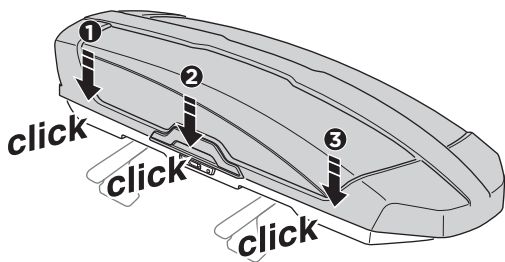

c

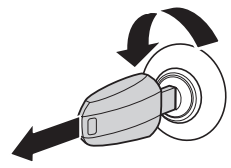
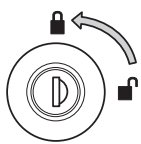
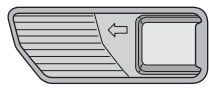
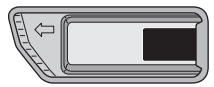



8

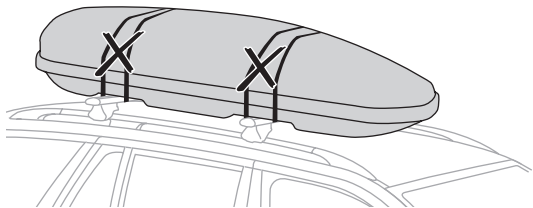
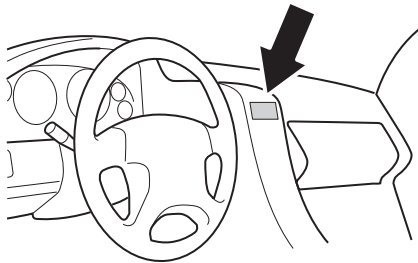
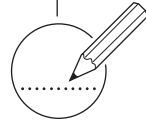
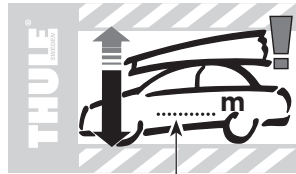
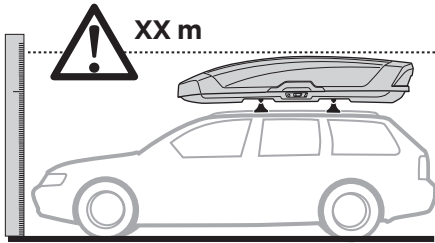
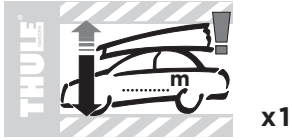

## Thule T-track Adapter

**696600** → 24x30 mm

**697600** → 20x27 mm

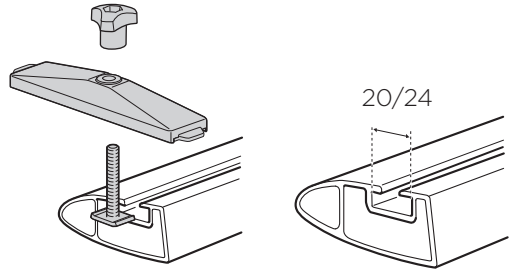

## Thule MultiLift

**572004**

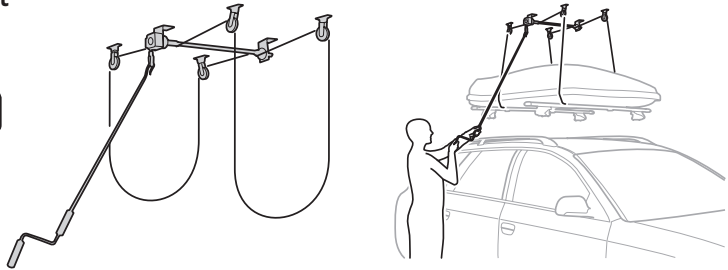

## Thule Box Ski Carrier Adapter

**694600** → Sport

**694800** → M

**694900** → XL/XXL

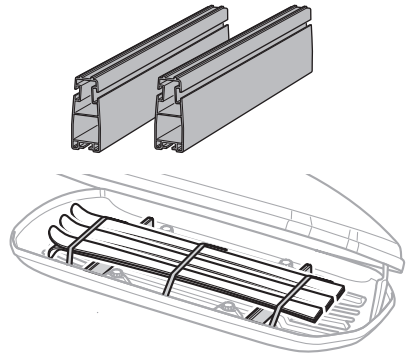

## Thule Box Lid Cover

**698100** → M

**698200** → Sport

**698300** → XL

**698400** → XXL

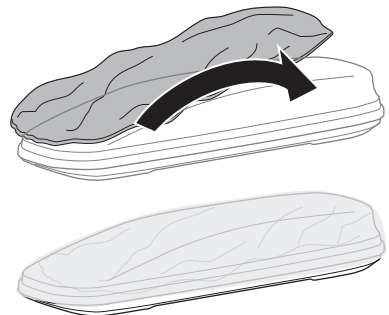

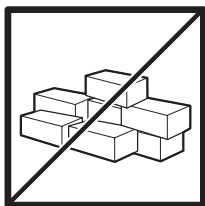
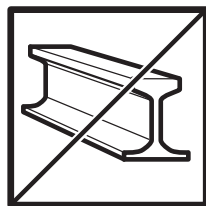
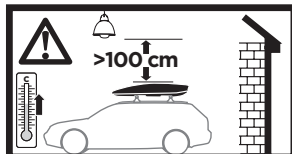
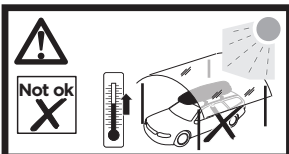
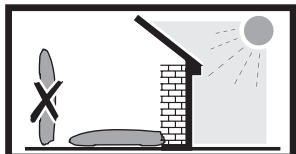
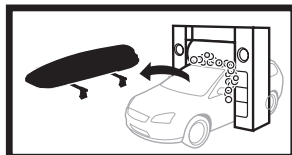
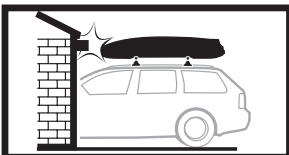
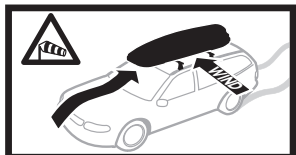
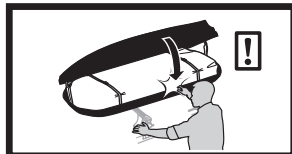
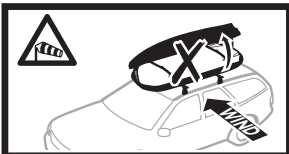
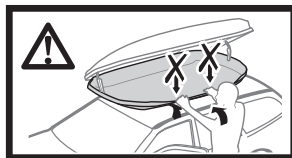
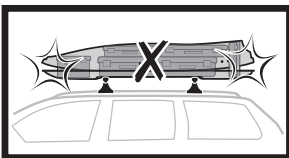
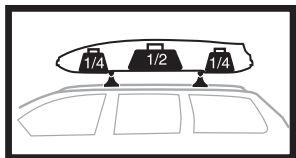

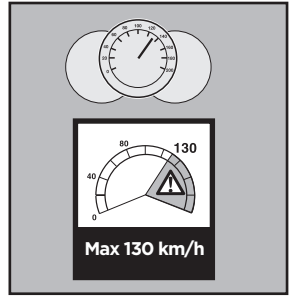
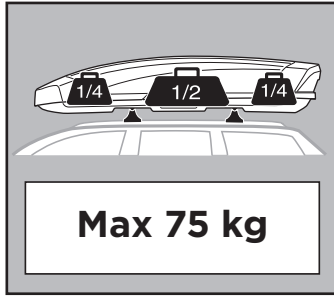

Sport	16 kg
M	17,5 kg
XL	23,5 kg
XXL	25,5 kg







## Thule One-Key System

544  (x4)

596  (x6)

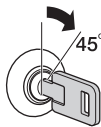
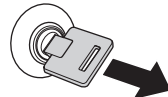
588  (x8)

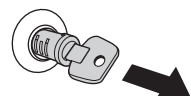
452  (x12)

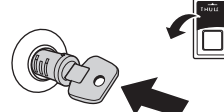
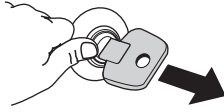
- 
- 
- 
- 
- 
- 
- 
- 