

# ➤ Instructions

## Thule Vector

613200, 613201, 613500, 613501, 613700, 613701

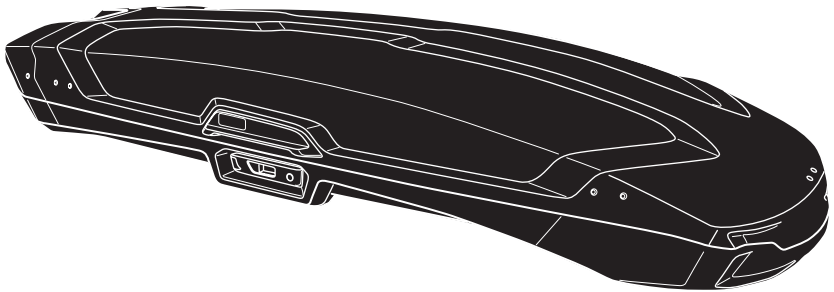

**EN** Roof box for roof-mounted racks  
**DE** Dachbox für Dachträger  
**FR** Coffre pour barres de toit  
**NL** Dakkoffer  
**IT** Box da tetto per portapacchi da installare sul tetto  
**ES** Cofre portaequipajes para barras de techo  
**PT** Caixa bagageira para barras de tejadilho  
**SV** Takbox för takmonterade räckor  
**DK** Tagboks til tagbjælter  
**NO** Takboks til takmonterte stativer  
**FI** Katolle asennettaviin telineisiin sopiva kuljetuslaatikko  
**ET** Katusele paigaldatav katuseboks  
**LV** Jumta kaste uz jumta uzstādāmiem bagāžniekiem  
**LT** Ant stogo tvirtinamų skersinių bagažinės  
**PL** Box dachowy na bagażnik montowany na dachu  
**RU** Грузовой бокс на крышу автомобиля  
**UK** Вантажний бокс для багажників для даху  
**BG** Кутия за багаж за релси, монтирани върху покрива  
**CS** Střešní box pro montáž na střeche  
**SK** Strešný box na strešné nosiče

**SL** Strešni kovček za strešne prtljažnike  
**HR/BIH** Krovna kutija za krovne nosače  
**RO** Portbagaj de acoperiş pentru cadru de bare montate pe acoperiş  
**HU** Tetőre szerelhető tetőbox  
**EL** Μπαγκκαζιέρα οροφής για μπάρες οροφής  
**TR** Araç üstüne bağlanan raflar için tavan kutusu  
**HE** תא חפצים ללגג הרכב  
**AR** صندوق سقف للحوامل المثبتة على السقف  
**ZH** 用于车顶架的车顶箱  
**JA** ルーフマウント型ラック用ルーフボックス  
**KO** 루프 장착 랙 루프 박스  
**TH** กล่องบนหลังคาสำหรับแร็คหลังคา

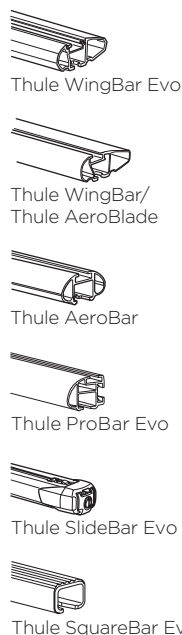
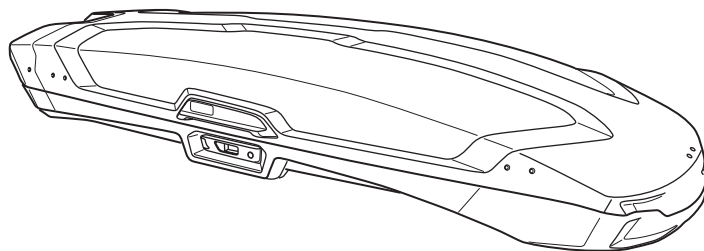
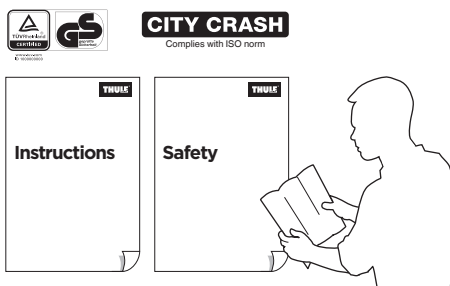

x1



x3



x2

**i**

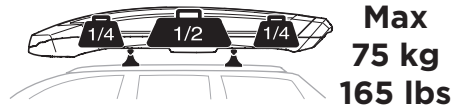

	Weight		Volume
Medium	29 kg	65 lbs	360 litre
Alpine	30 kg	66 lbs	380 litre
Large	30 kg	66 lbs	430 litre

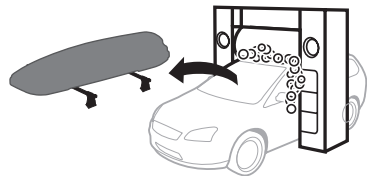
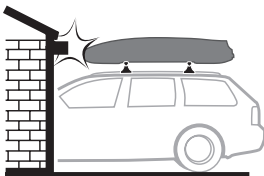
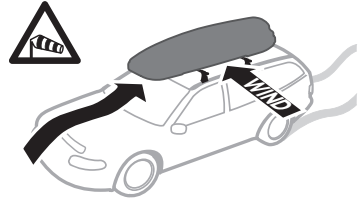
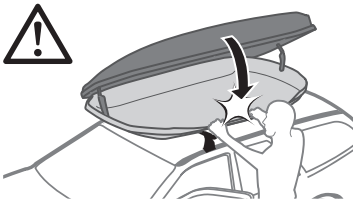
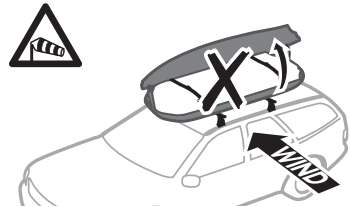
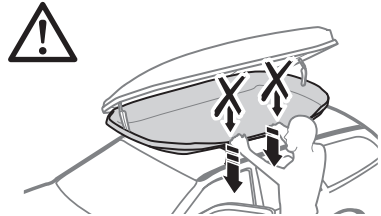
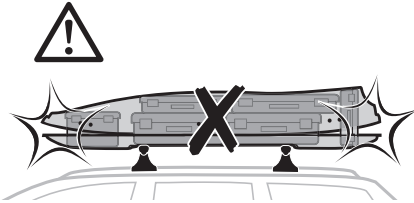
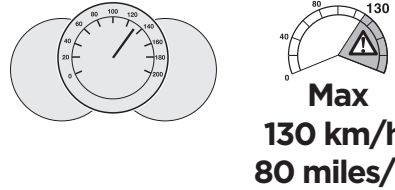

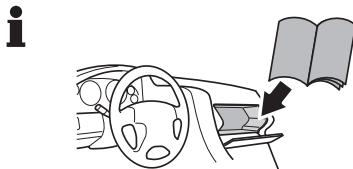
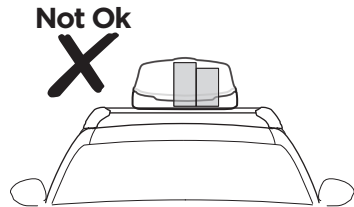
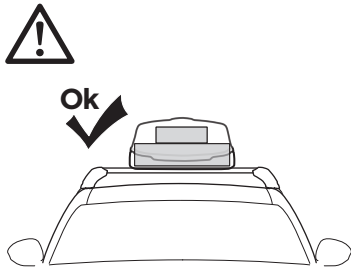
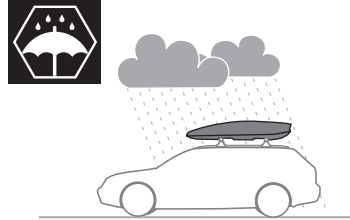
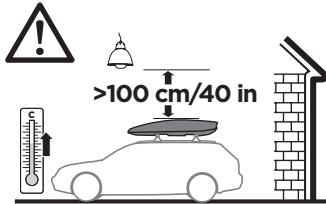
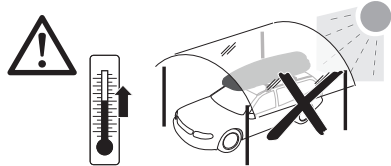
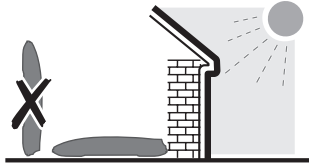

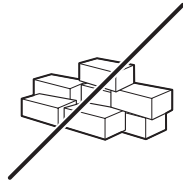
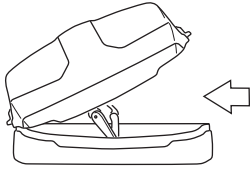

**i**

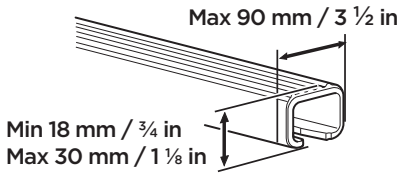

Thule T-track Adapter

696600  
697600

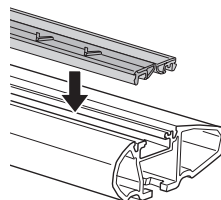
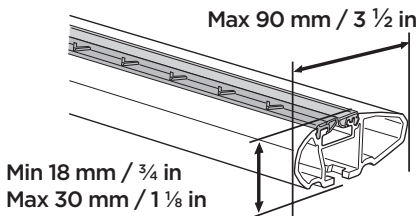

**i**

		D Min	D Max	W in	W out	H	L	R Min
Medium	mm	557	932	780	880	297	2120	1310
	in	21 <sup>7</sup> / <sub>8</sub>	36 <sup>3</sup> / <sub>4</sub>	30 <sup>3</sup> / <sub>4</sub>	34 <sup>5</sup> / <sub>8</sub>	11 <sup>3</sup> / <sub>4</sub>	83 <sup>1</sup> / <sub>2</sub>	51 <sup>1</sup> / <sub>2</sub>
Alpine	mm	557	932	780	884	284	2280	1370
	in	21 <sup>7</sup> / <sub>8</sub>	36 <sup>3</sup> / <sub>4</sub>	30 <sup>3</sup> / <sub>4</sub>	34 <sup>3</sup> / <sub>4</sub>	11 <sup>1</sup> / <sub>8</sub>	89 <sup>3</sup> / <sub>4</sub>	53 <sup>7</sup> / <sub>8</sub>
Large	mm	557	932	780	884	329	2315	1410
	in	21 <sup>7</sup> / <sub>8</sub>	36 <sup>3</sup> / <sub>4</sub>	30 <sup>3</sup> / <sub>4</sub>	34 <sup>3</sup> / <sub>4</sub>	13	91 <sup>1</sup> / <sub>8</sub>	55 <sup>3</sup> / <sub>8</sub>

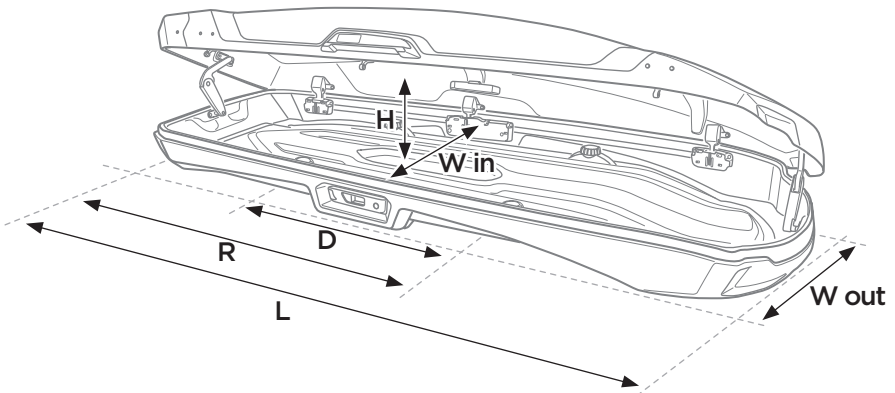
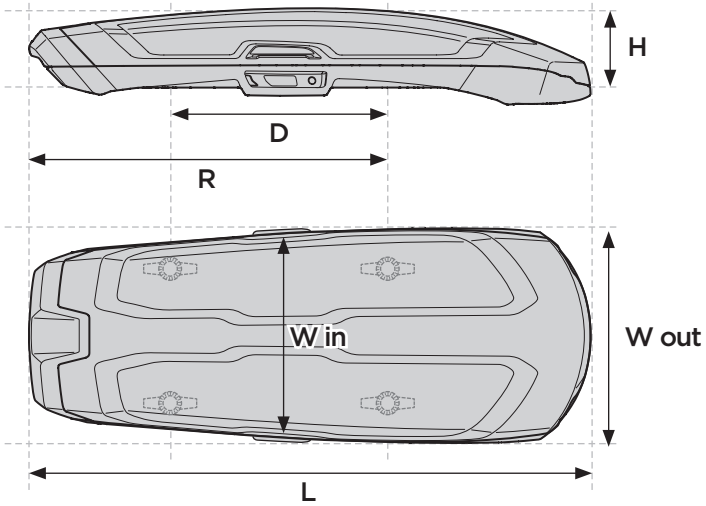

1

i

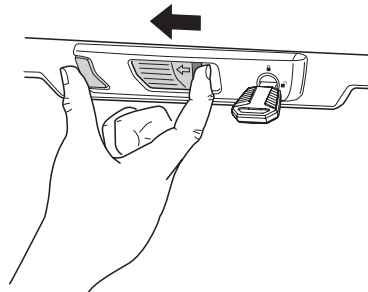
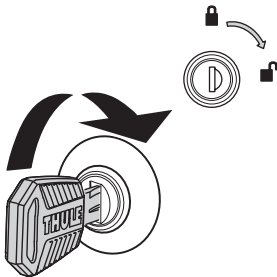
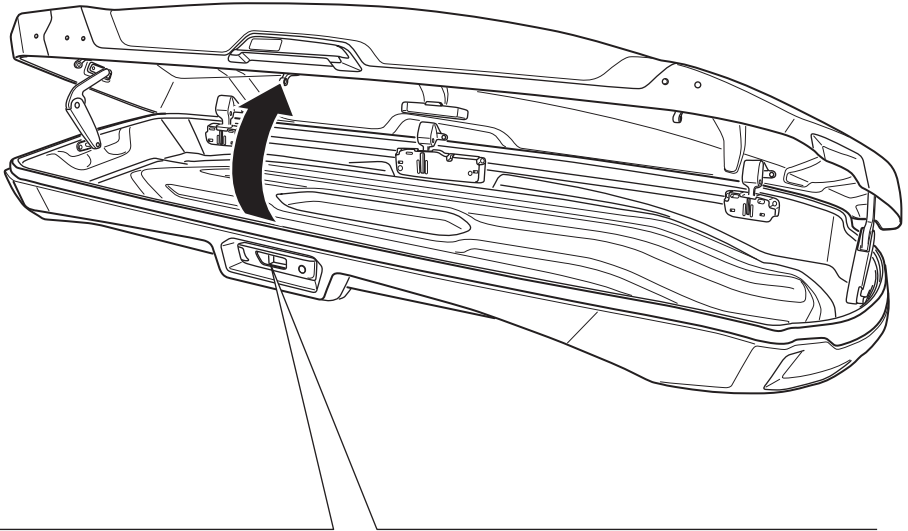
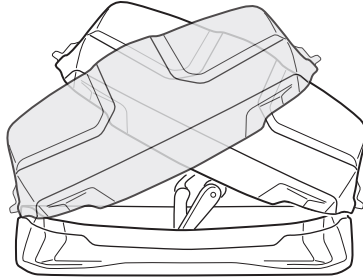

2

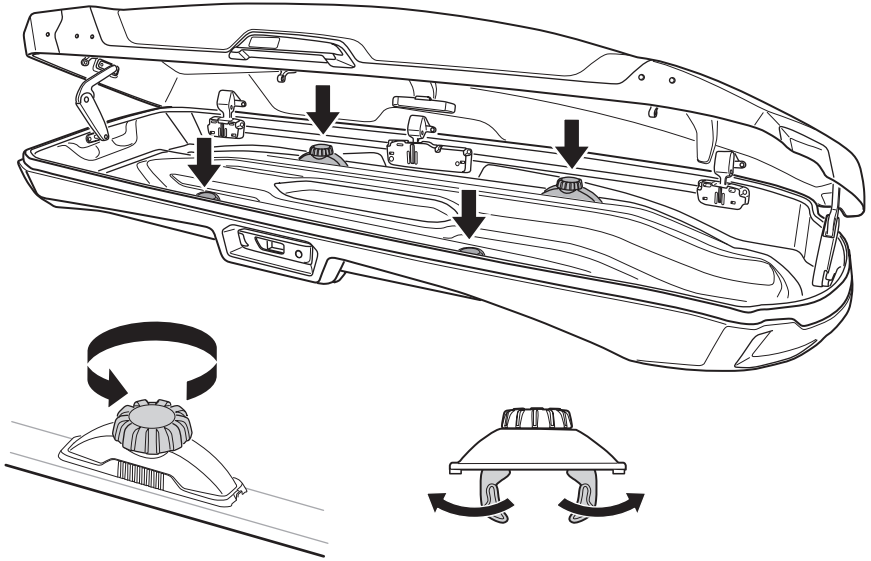

**i**



x 2

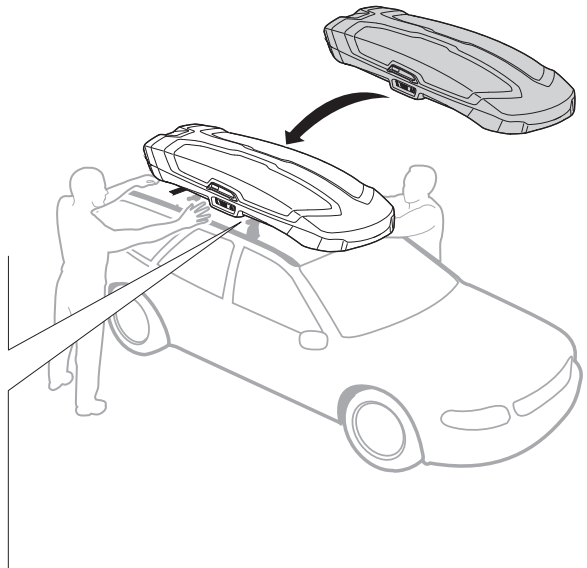
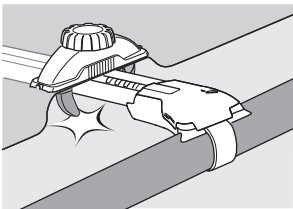



3

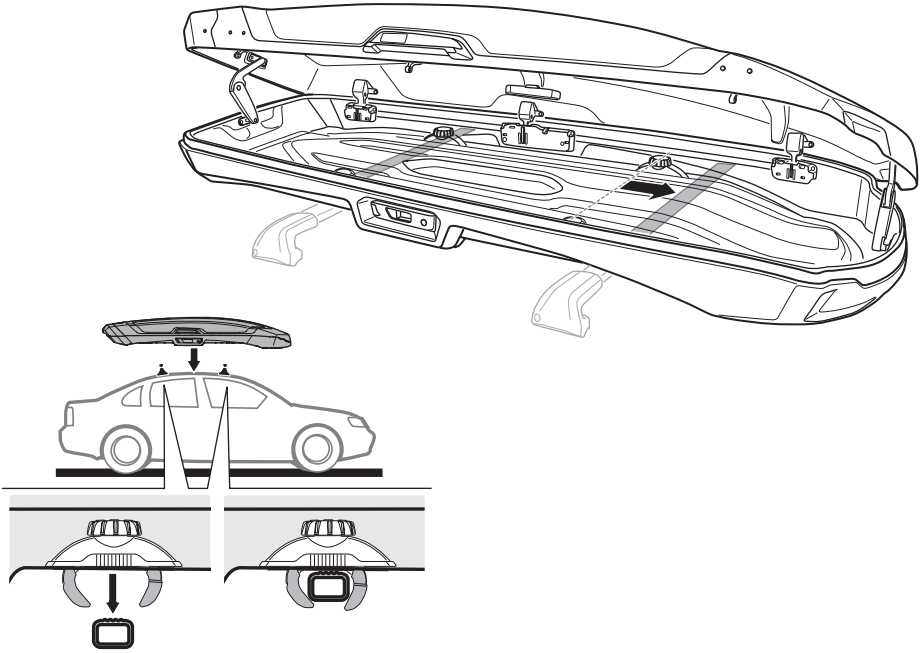

4

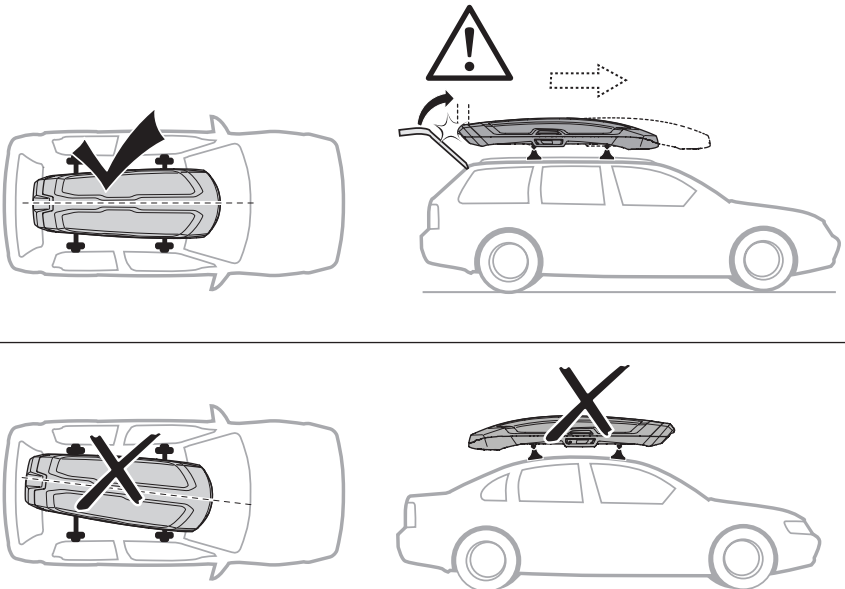

5

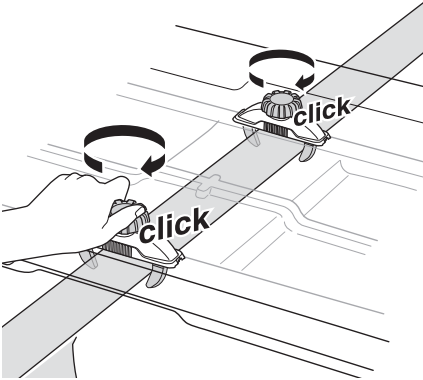
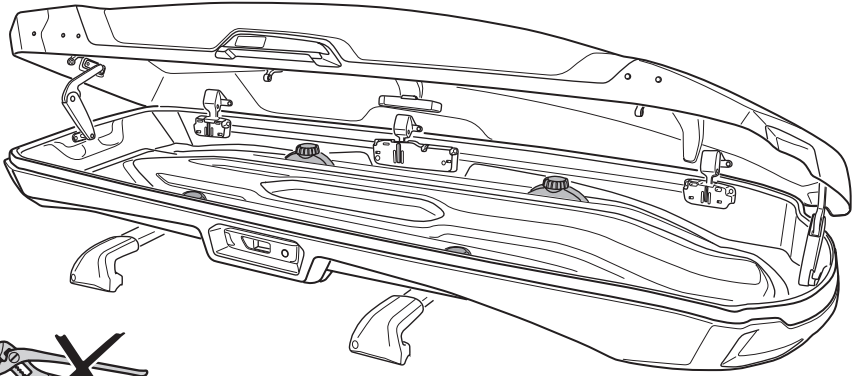

**i**

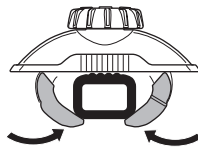
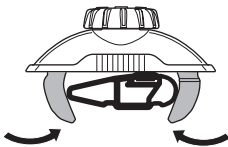
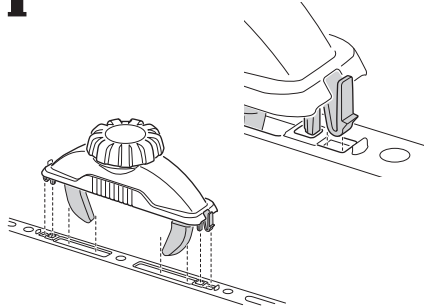

**Ok**  
✓

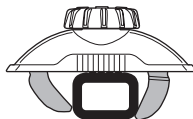
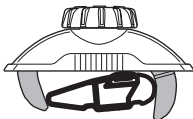

**Not Ok**  
✗

6



LED



IP43

-30°C  
+60°C

50000x

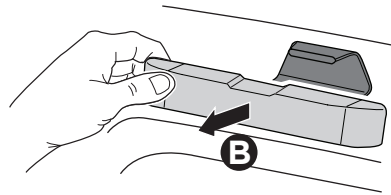
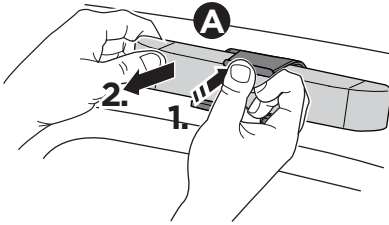
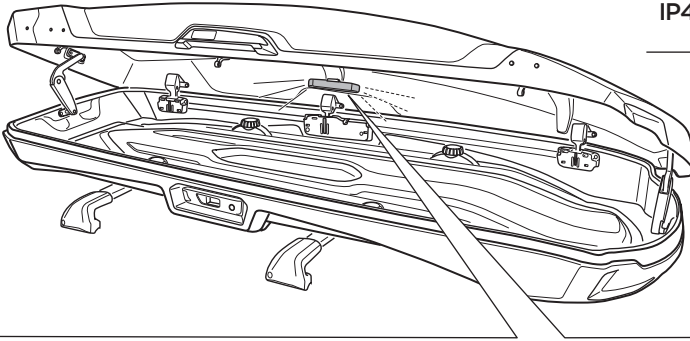

7

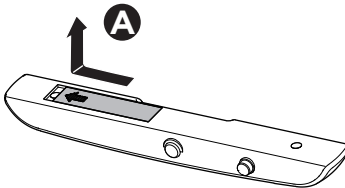

3 x Energizer L92  
(1.5 VDC)

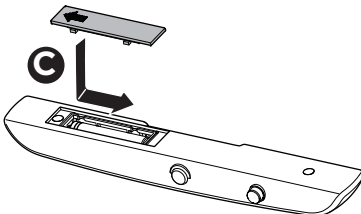
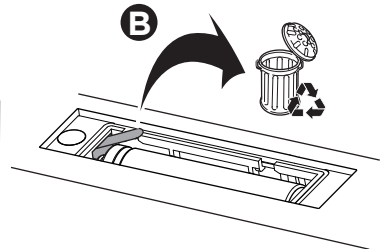
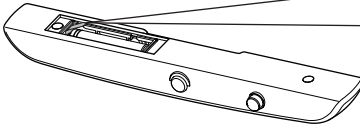

8

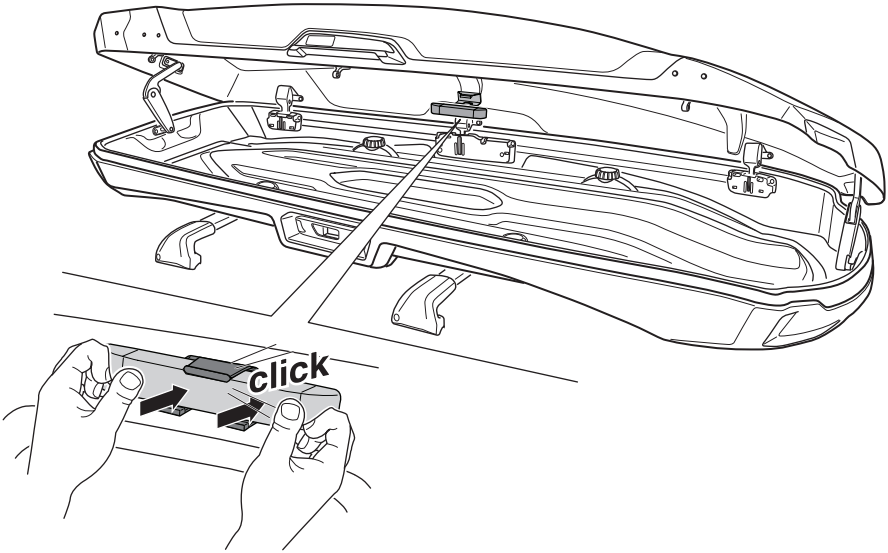

9



ON/OFF

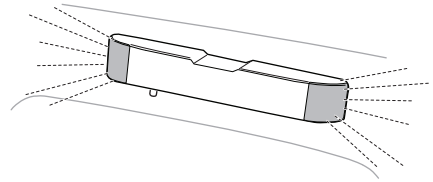
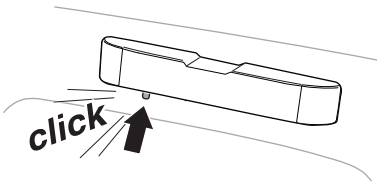

i

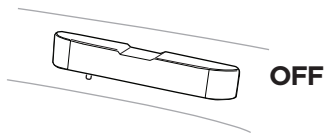
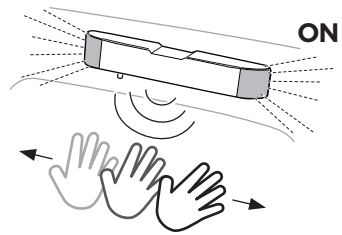
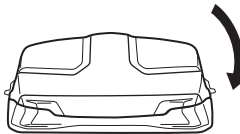
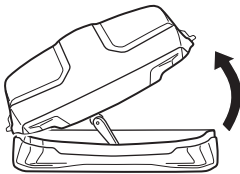

# 10

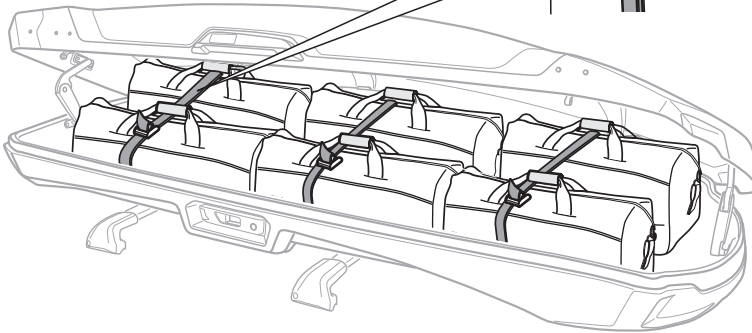
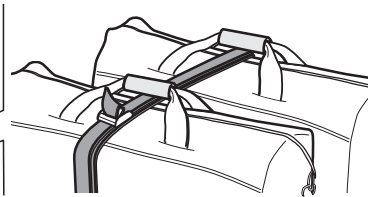
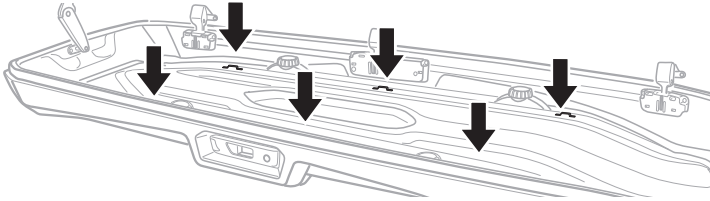
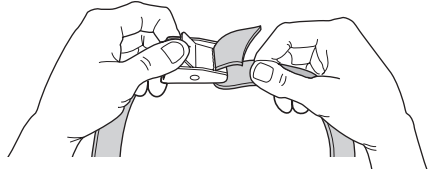

Not Ok

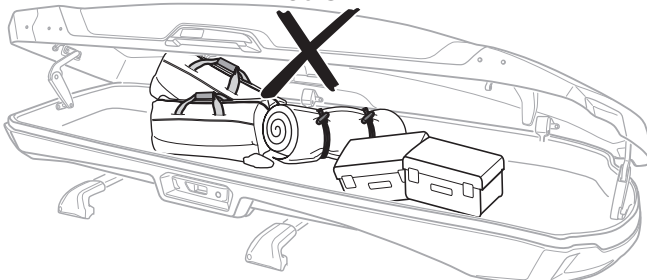

11

A

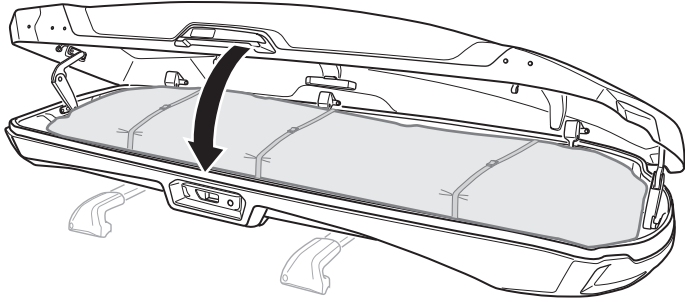

B

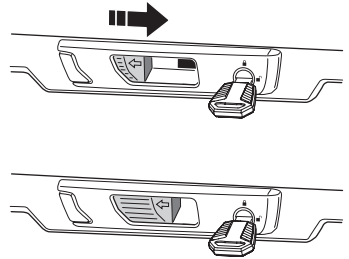
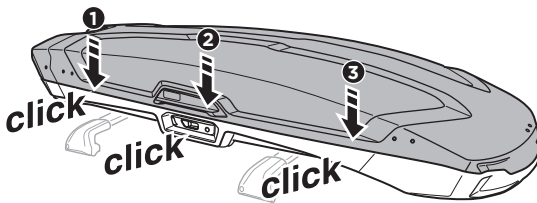

C

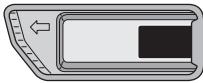

Not ok  
X

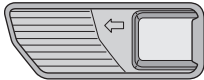

ok  
→

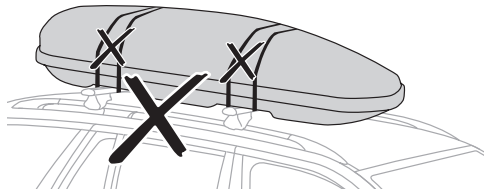
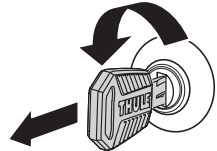
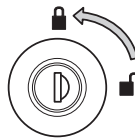

12

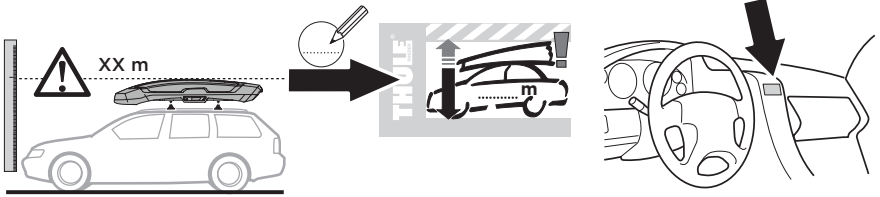

**i**

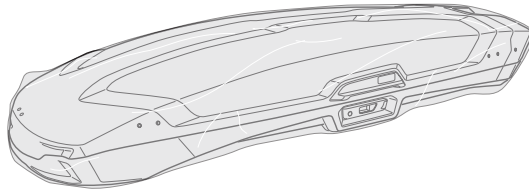
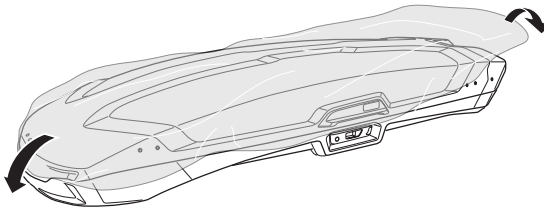

**i**

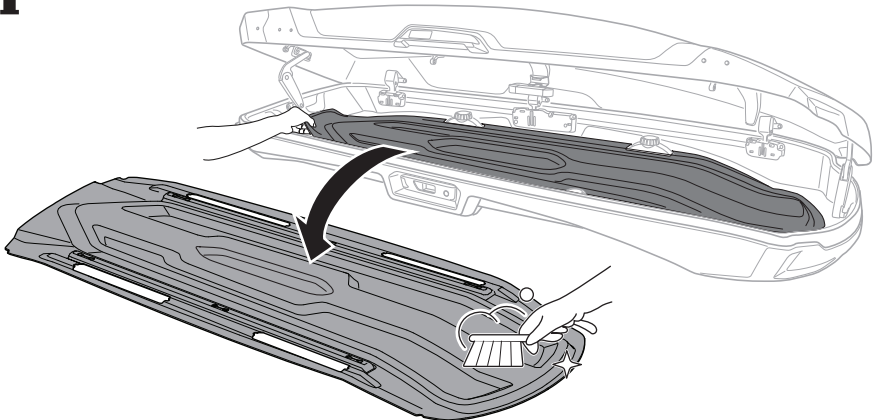

<b>EN</b> Accessories	<b>DK</b> Tilbehør	<b>UK</b> Аксессуары	<b>EL</b> Εξαρτήματα
<b>DE</b> Zubehör	<b>NE</b> Tilbehør	<b>BG</b> Принадлежности	<b>TR</b> Aksesuarlar
<b>FR</b> Accessoires	<b>FI</b> Lisävarusteet	<b>CS</b> Doplňky	<b>AR</b> الملحقات
<b>NL</b> Accessoires	<b>ET</b> Lisavarustus	<b>SK</b> Príslušenstvo	<b>HE</b> אביזרים
<b>IT</b> Accessori	<b>LV</b> Piederumi	<b>SL</b> Dodatki	<b>ZH</b> 附件
<b>ES</b> Accesorios	<b>LT</b> Priedai	<b>HR/BiH</b> Dodaci	<b>JA</b> アクセサリー
<b>PT</b> Acessórios	<b>PL</b> Akcesoria	<b>RO</b> Accesorii	<b>KO</b> 액세서리
<b>SV</b> Tillbehör	<b>RU</b> Аксессуары	<b>HU</b> Tartozékok	<b>TH</b> อุปกรณ์เสริม

## Thule One-Key System

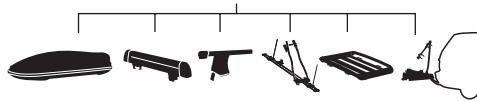

**450400** (x4)

**450600** (x6)

**450800** (x8)

**451200** (x12)

**451600** (x16)

## Thule T-track Adapter

**696600**



24x30 mm

**697600**



20x27 mm

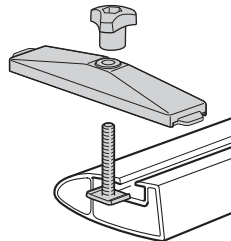

20/24

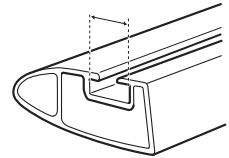

## Thule MultiLift

**572004**

