

Thule ThruRide 565

› Instructions



www.thule.com
ID 1000000000

CITY CRASH
Complies with ISO norm



THULE WingBar

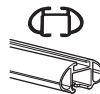

THULE AeroBar



THULE SlideBar



THULE ProBar

565001

C.20151019
501-8124-01

Bring your life
thule.com

EN Roof-mounted bike carrier
DE Dachfahrradträger
FR Porte-vélo sur le toit
NL Fietsdrager voor op het dak
IT Portabici da installare sul tetto
ES Portabicicletas de techo
PT Suporte para bicicleta para teto
SV Takmonterad cykelhållare
DK Tagmonteret cykelholder
NO Takmonterte lasteholdere
FI Katolle asennettava polkupyöräteline
ET Katusele paigaldatav jalgrattahoidik
LV Uz jumta uzstādāms velosipēdu turētājs
LT Ant stogo tvirtinami dviračių laikikliai
PL Bagażnik rowerowy montowany na dachu
RU Устанавливаемое на крыше крепление для велосипедов

UK Багажник для велосипедів, що монтується на даху
BG Покривен багажник за велосипеди
CS Nosič jízdních kol s montáží na střechu
SK Nosič bicyklov s montážou na strechu
SL Nosilec za kolesa
HR/BiH Krovni nosač bicikla
RO Suport pentru bicicletă montat pe pavilion
HU Tetőre szerelhető kerékpártartó
EL Σχάρα ποδηλάτου οροφής
TR Araç üstüne bağlanan bisiklet taşıyıcı
HE משא אופניי המרכב על הגג
AR حامل الدراجة للتثبيت على السقف
ZH 頂置自行車架
JA ルーフマウント型サイクルキャリア
KO 지붕 장착 자전거 캐리어
TH โครงยึดจักรยานแบบติดตั้งบนหลังคา

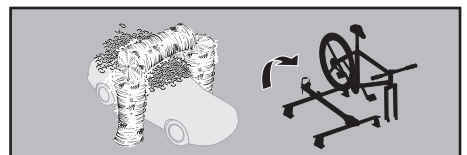
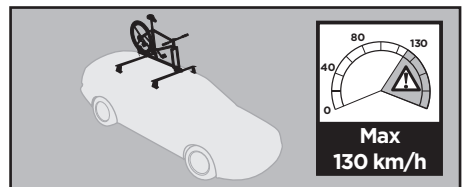
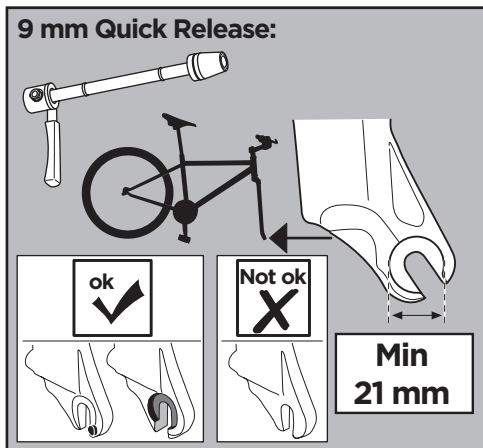
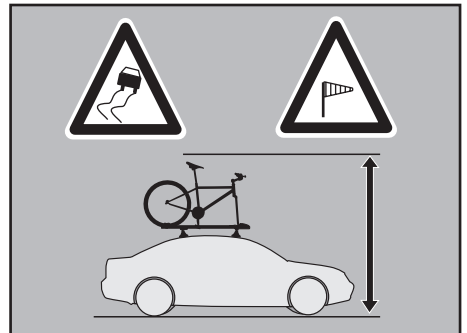
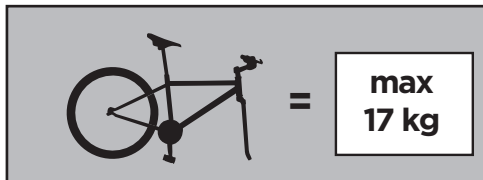
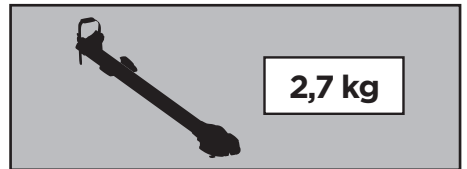

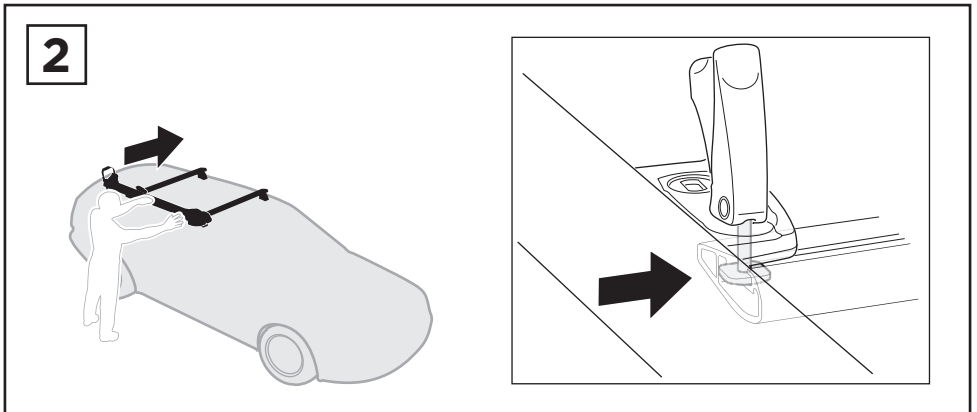
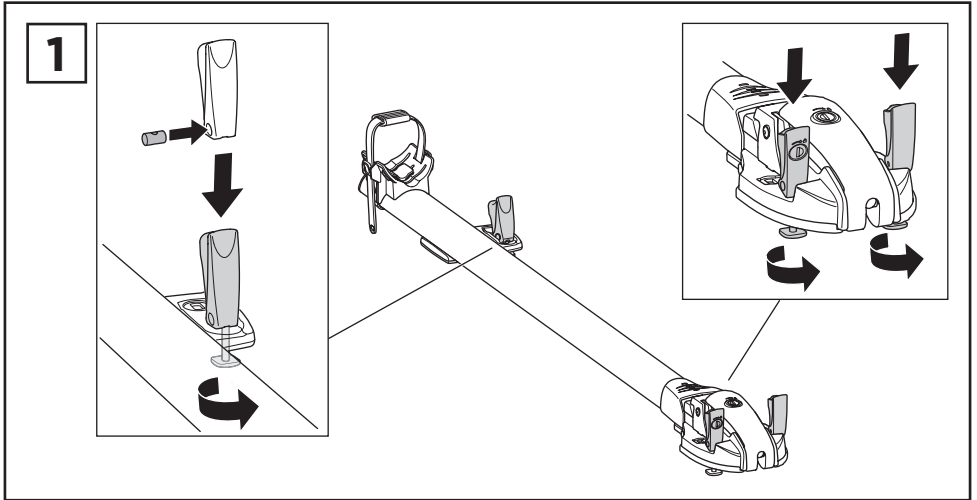
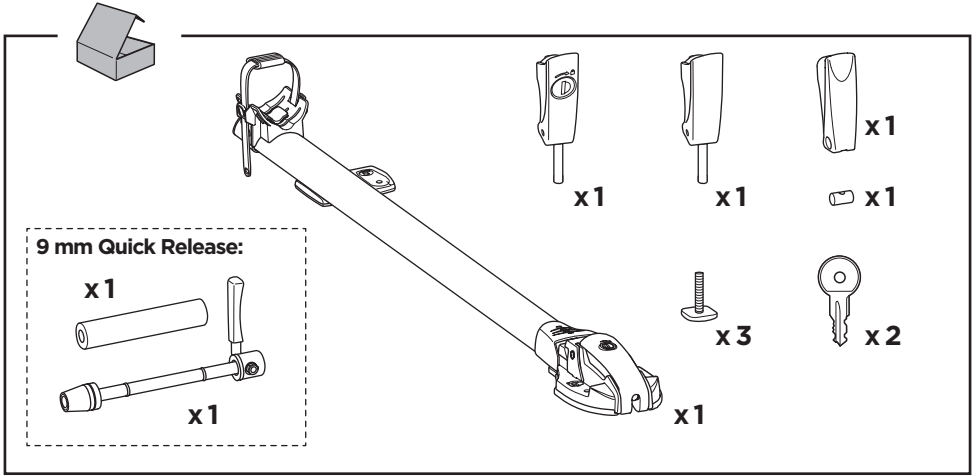

3

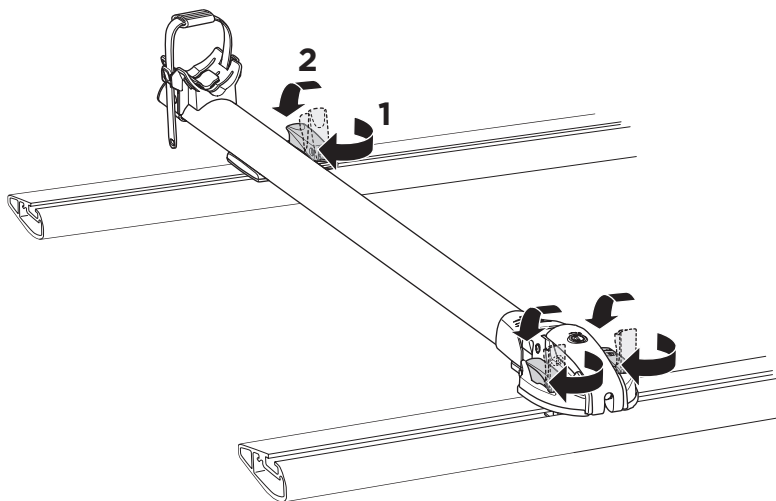

4

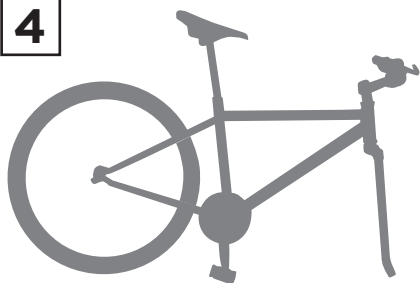

9 mm Quick Release:

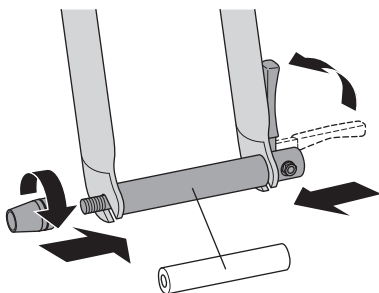

12-20 mm Thru Axles:

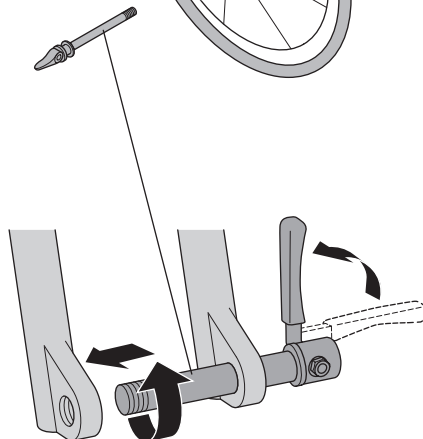
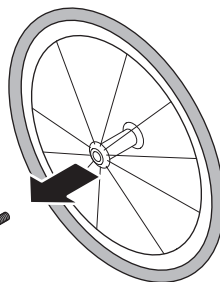

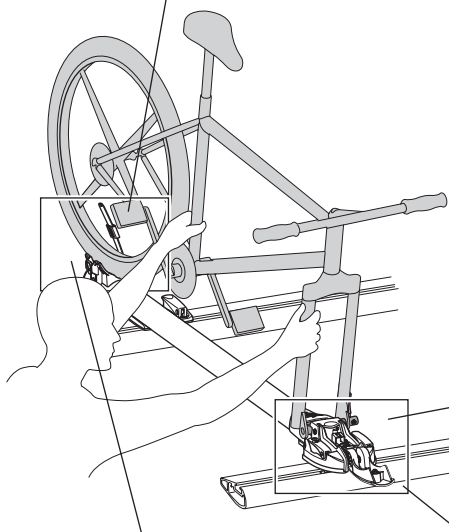
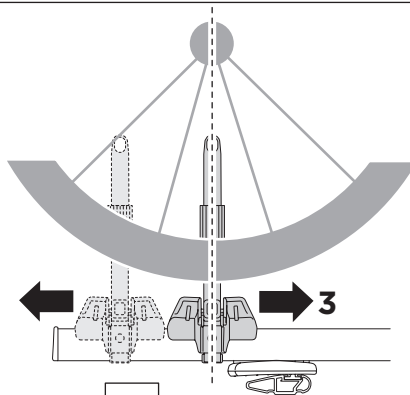
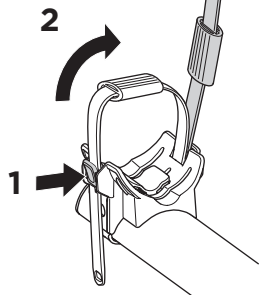
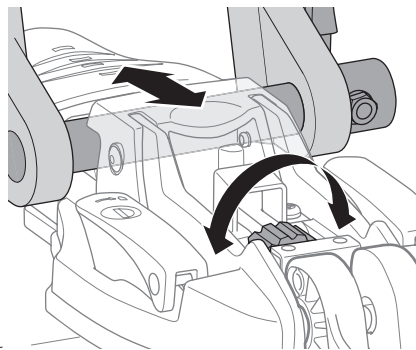
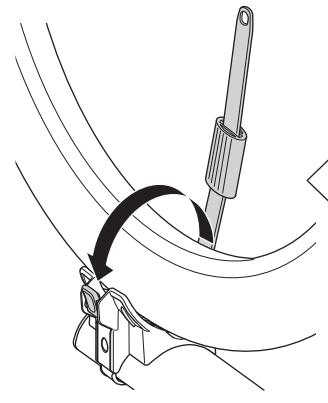
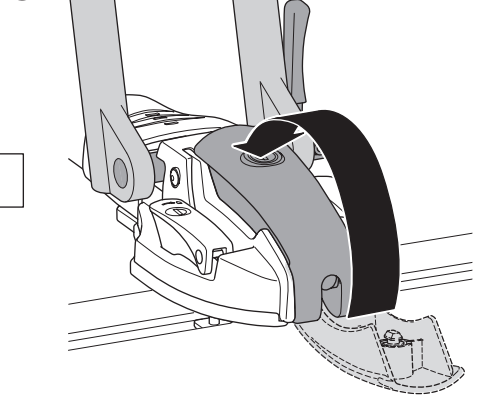
5**A****B****D****C**

6



x1

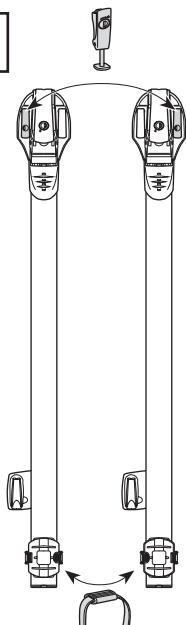
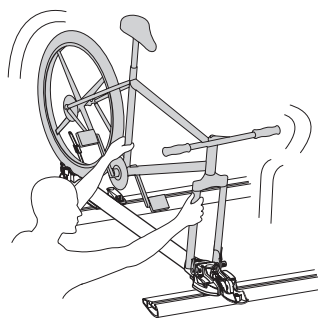
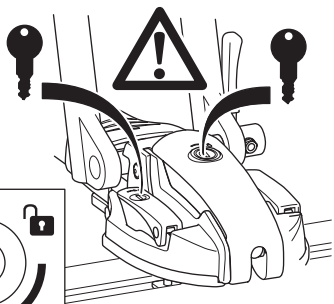
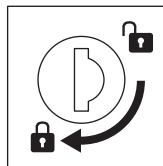

EN Left-hand fitting

DE Montage links

FR Montage côté gauche

NL Montage aan de linker kant

IT Montaggio a sinistra

ES Montaje a izquierda

PT Montagem do lado esquerdo

SV Vänstermonterad

DK Venstremontering

NO Venstremontering

FI Asennus vasemmalle

ET Vasakpoolne kinnitamine

LV Kreisais stiprinājums

LT Kairysis pritvirtinimas

PL Montaż z lewej

RU Установка на левую сторону

UK Установка на ліву сторону

BG Монтаж отляво

CS Montáž z levé strany

SK Montáž na ľavej strane

SL Pritrjevanje z leve strani

HR/BiH Montaža sa lijeve strane

RO Montare pe partea stângă

HU Bal oldalról szerelhető

EL Τοποθέτηση αριστερά

TR Sol elle montaj

AR التركيب في الجانب الأيسر

HE התקנה מהצד השמאלי

ZH 从左侧安装

JA 左手装着

KO 왼손 장착

TH ตัวยึดด้านซ้ายมือ

A

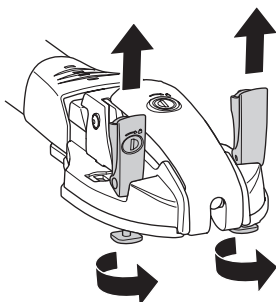

B

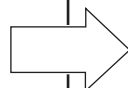
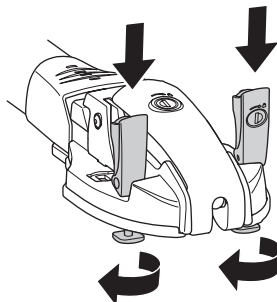

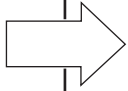

i

C

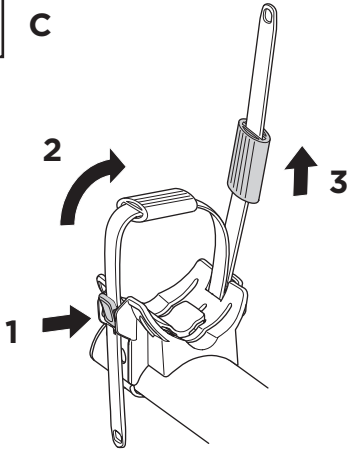

D

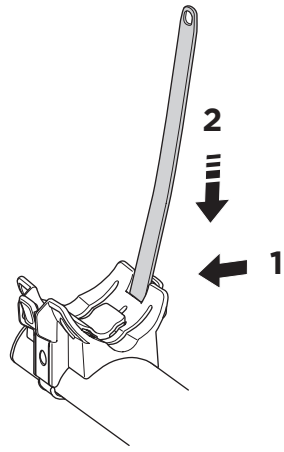

E

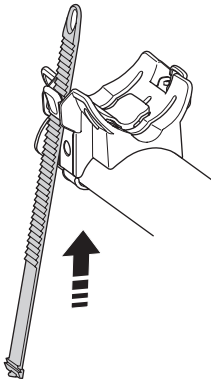

F

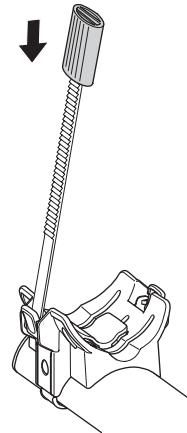

i

9 mm Quick Release:

12-20 mm Thru Axles:

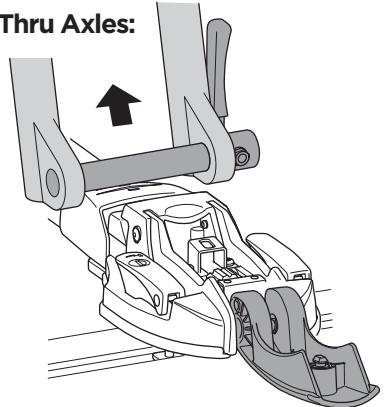
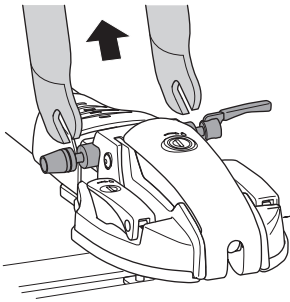

EN Accessories	DK Tilbehør	UK Аксессуары	EL Εξαρτήματα
DE Zubehör	NO Tilbehør	BG Принадлежности	TR Aksesuarlar
FR Accessoires	FI Lisävarusteet	CS Doplňky	الملاحقا AR
NL Accessoires	ET Lisavarustus	SK Príslušenstvo	אביזרים HE
IT Accessori	LV Piederumi	SL Dodatki	ZH 附件
ES Accesorios	LT Priedai	HR/BiH Dodaci	JA アクセサリー
PT Acessórios	PL Akcesoria	RO Accesorii	KO 액세서리
SV Tillbehör	RU Аксессуары	HU Tartozékok	TH อุปกรณ์เสริม

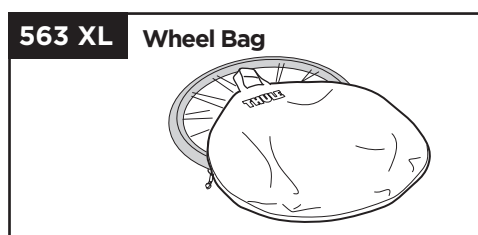
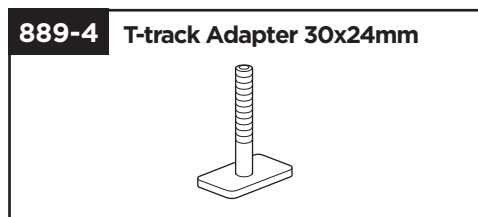
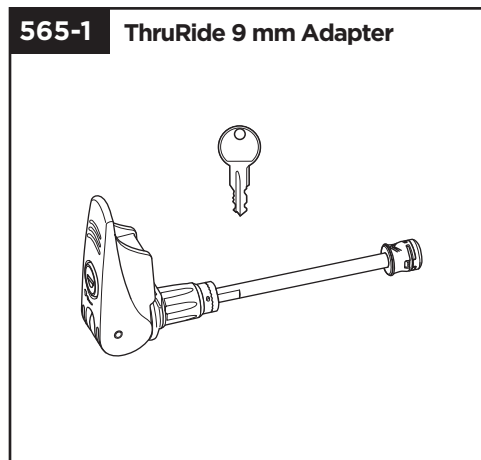

Thule One-Key System

544		(x4)
596		(x6)
588		(x8)
452		(x12)

